



LED PROFILE

2019 V1.0

CREATING VALUE FOR YOU

PURE LIGHT LED PRODUCTS

CONTENTS

ENTERPRISE BRIEF	04
BRAND	06
PRODUCT NAMING RULES	08
ICON DESCRIPTION	09
PRODUCT LIST	10
NEW PROFILE	22
MINI PROFILE	42
BENDABLE PROFILE	48
DECORATIVE PROFILE	60
REGULAR PROFILE	92
FREE ASSEMBLE PROFILE	170
WATERPROOF PROFILE	184
LINEAR PROFILE	192
ACCESSORIES LIST	228
END	231

PRODUCT LIST

NEW PROFILE

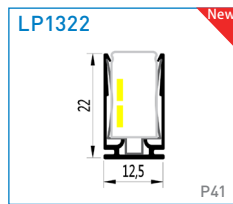
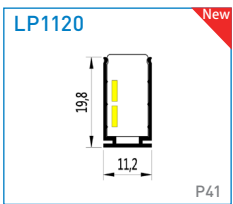
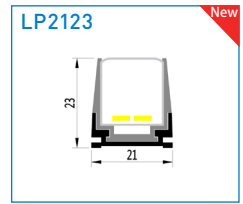
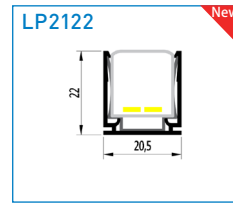
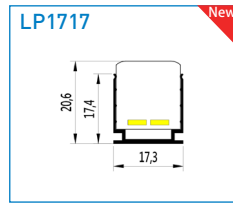
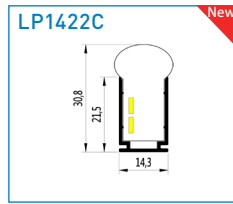
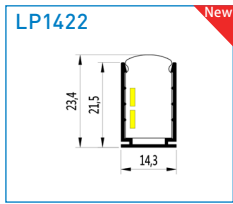
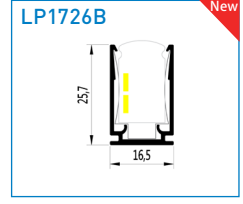
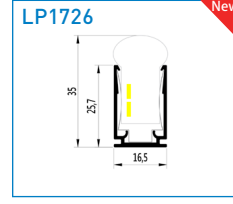
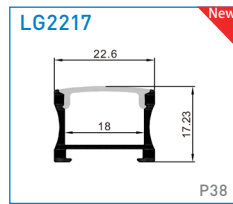
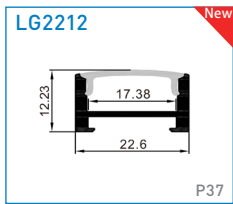
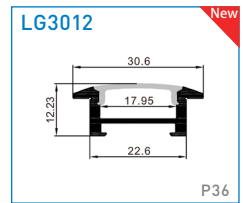
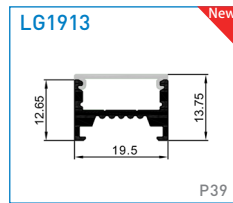
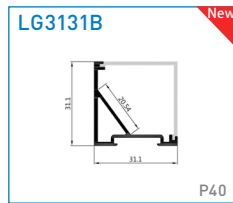
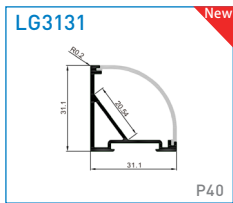
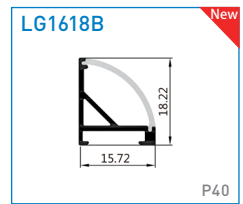
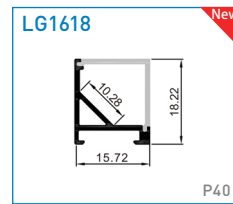
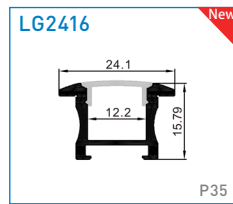
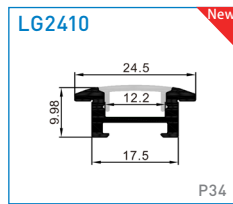
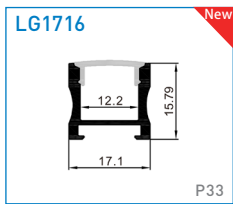
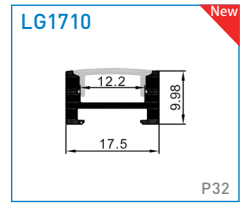
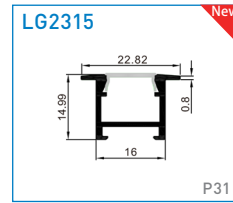
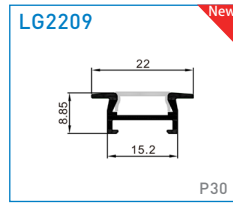
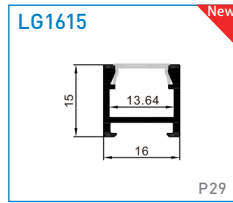
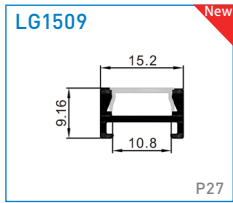

MINI PROFILE

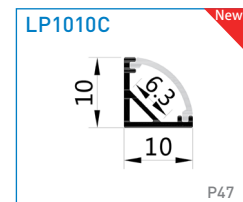
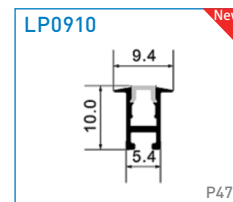
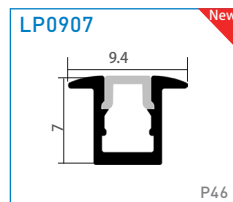
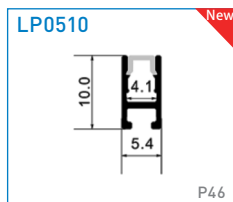
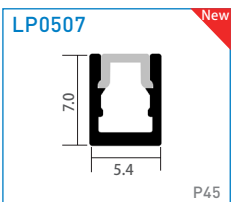

BENDABLE PROFILE

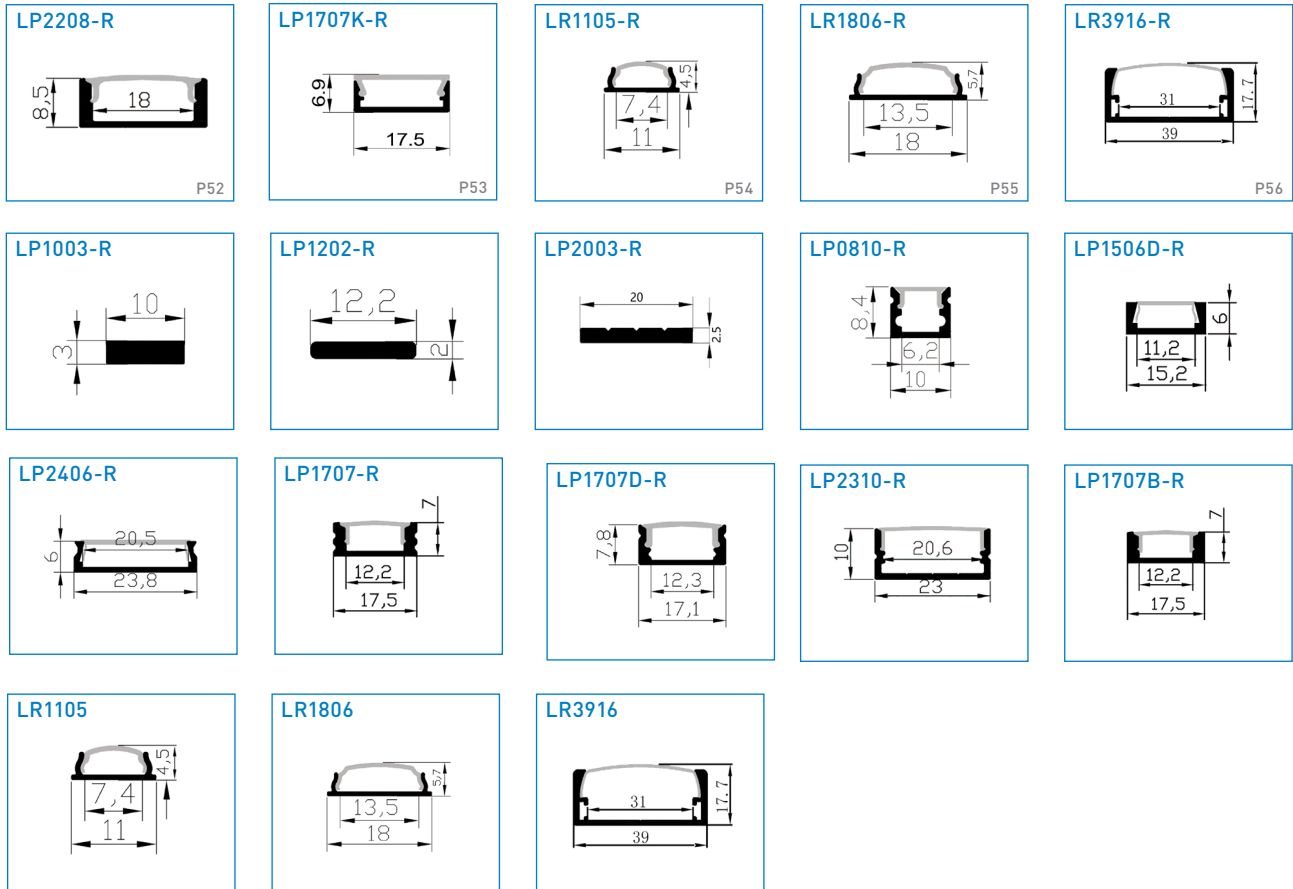

DECORATIVE PROFILE

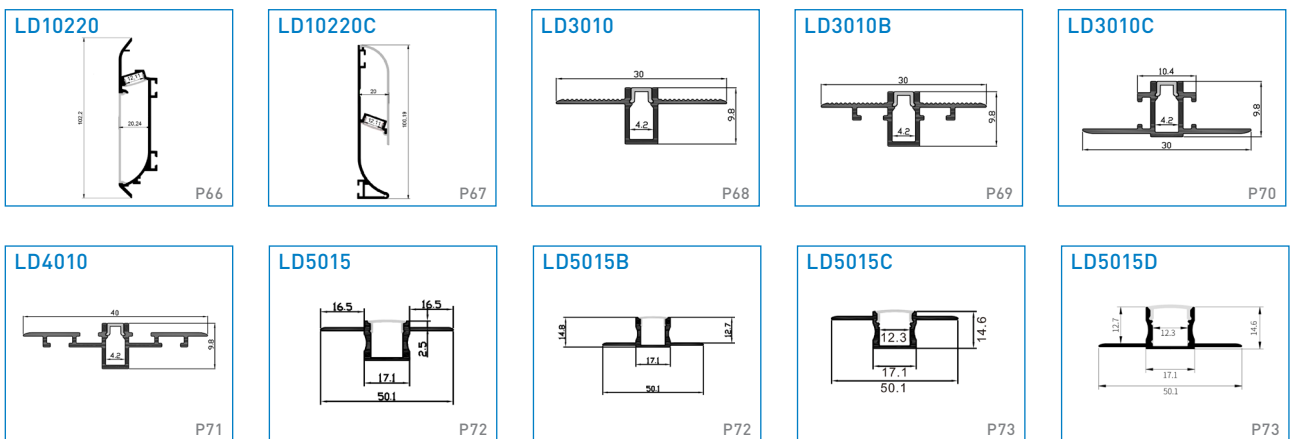

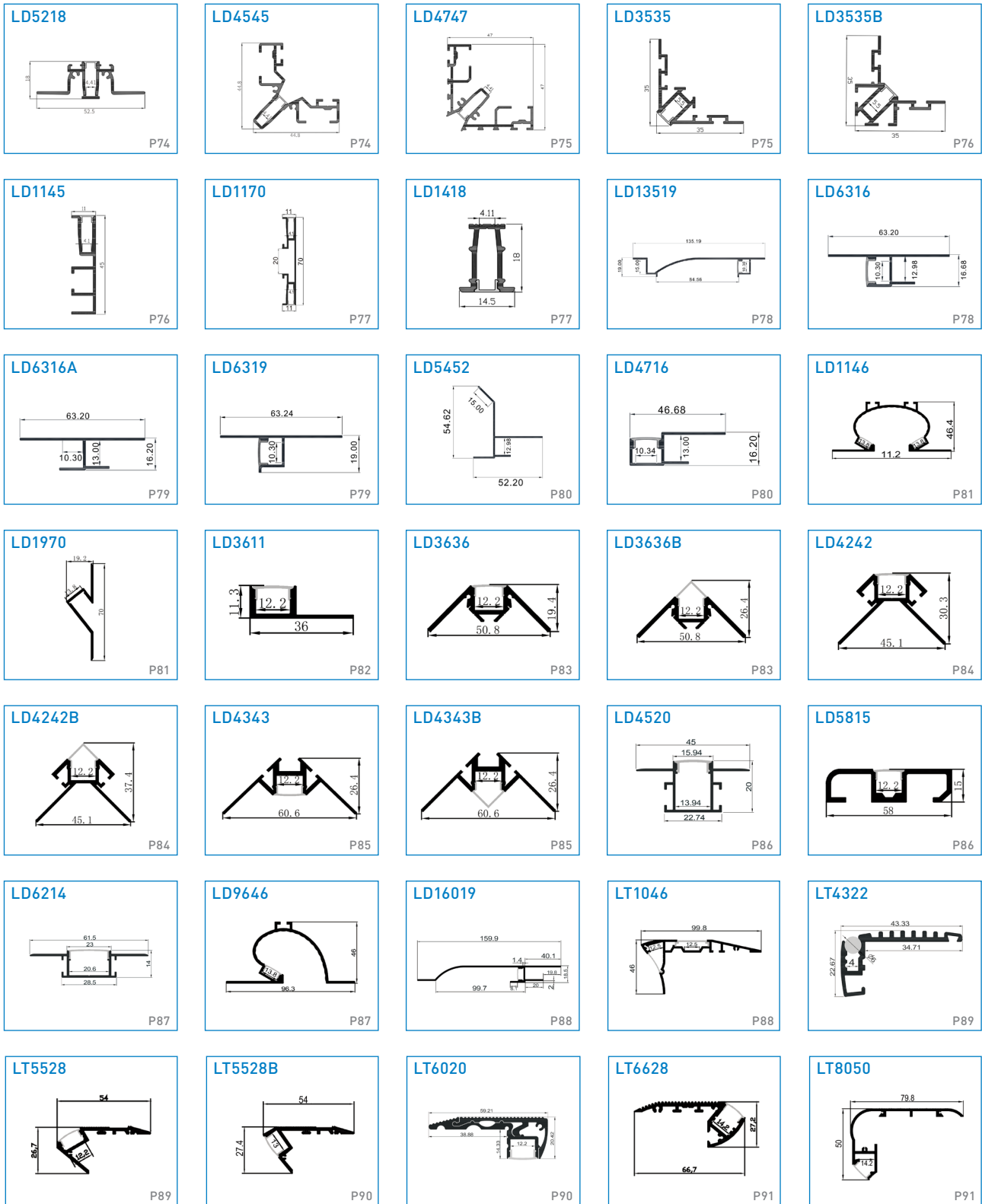

REGULAR PROFILE

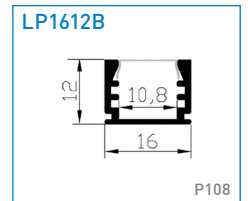
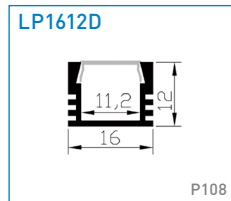
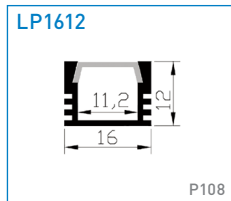
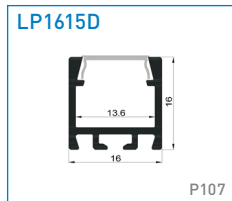
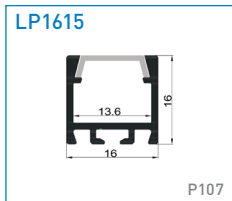
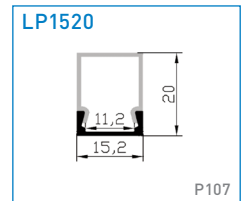
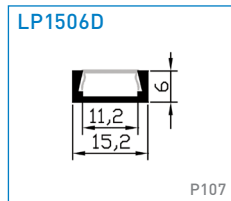
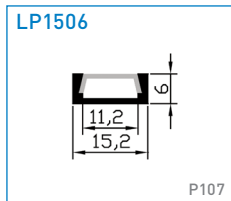
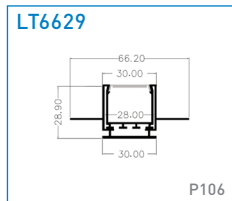
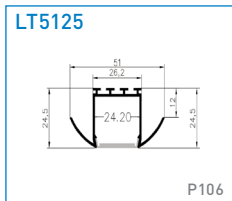
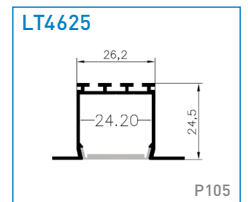
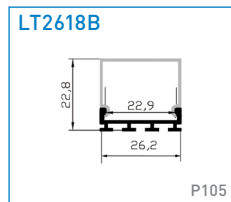
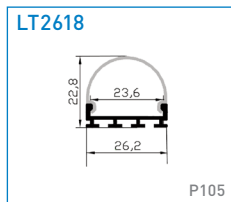
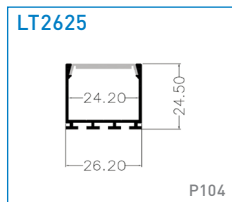
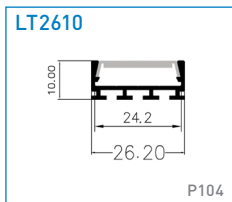
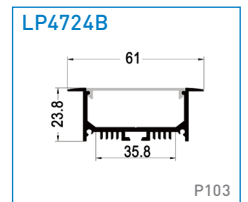
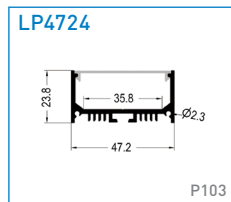
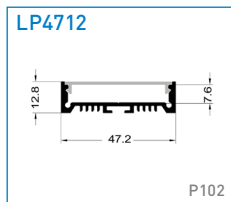
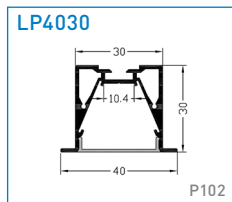
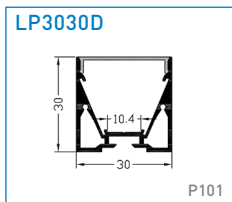
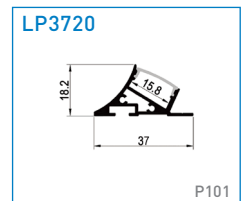
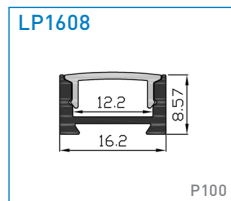
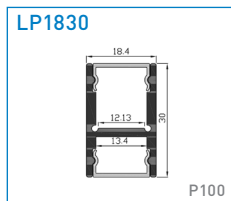
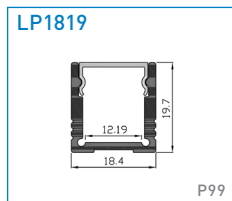
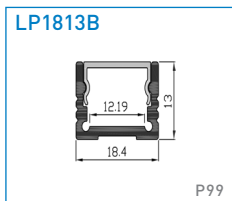
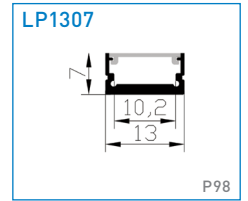
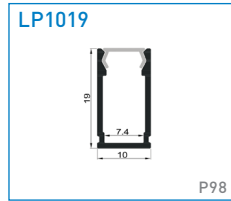
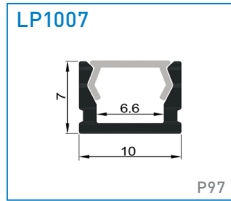
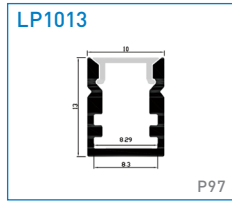
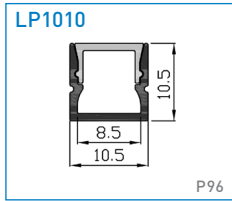
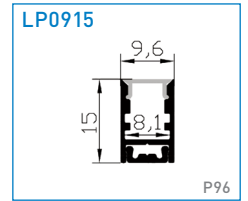
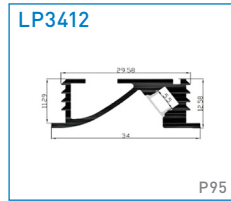
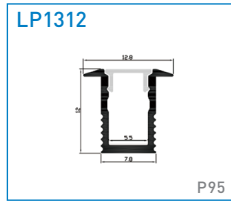
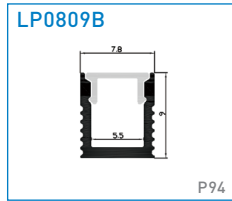
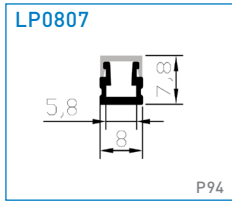

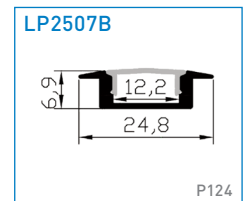
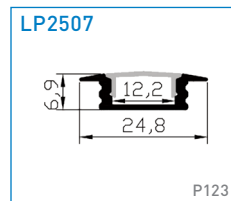
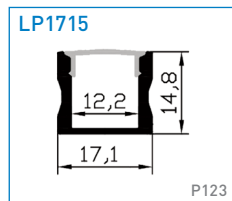
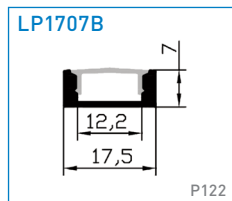
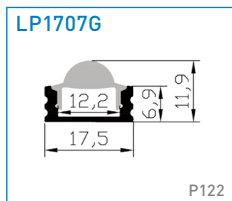
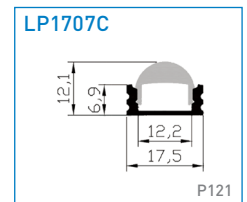
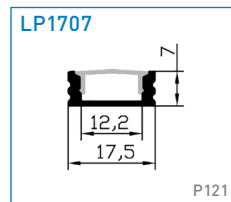
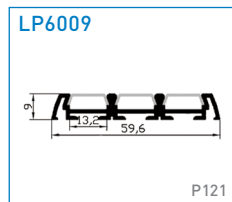
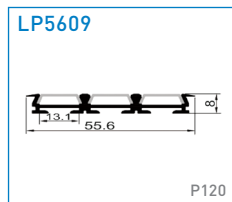
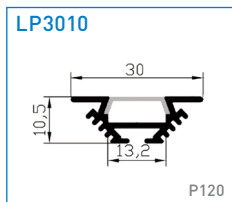
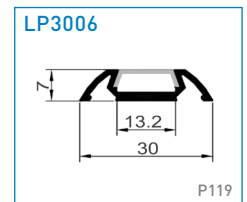
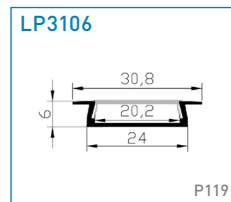
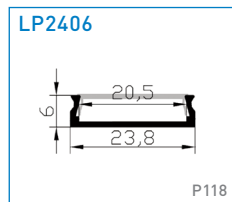
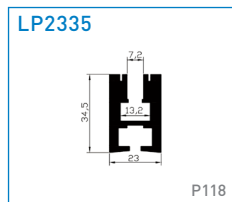
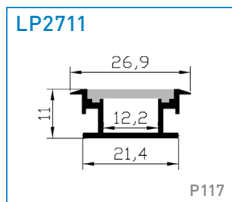
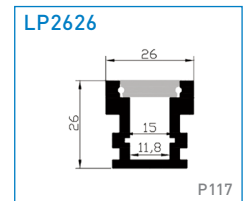
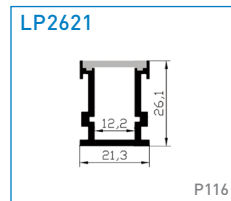
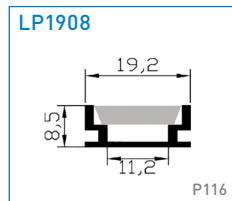
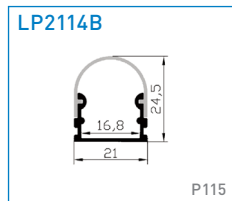
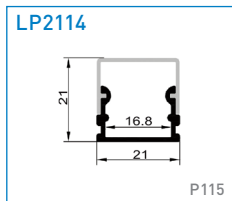
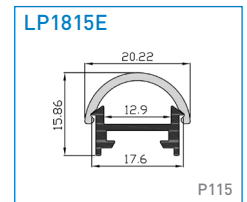
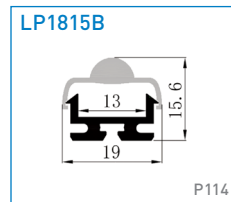
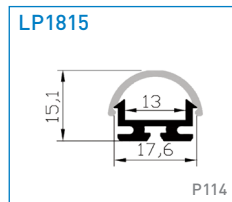
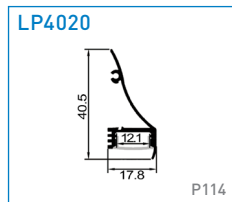
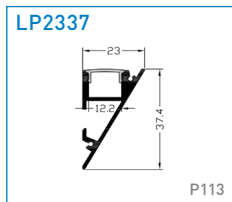
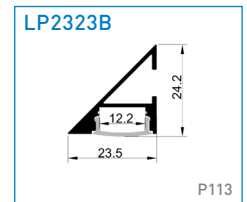
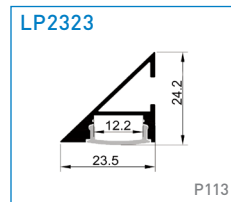
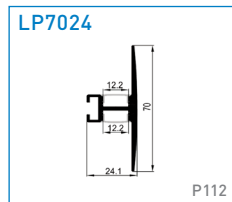
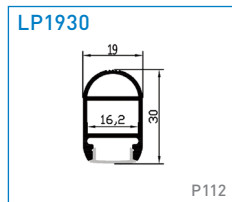
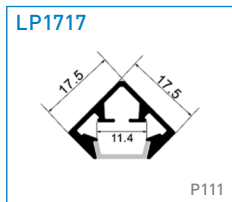
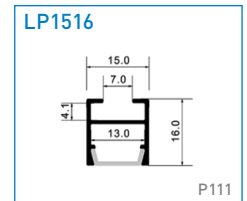
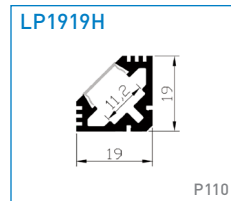
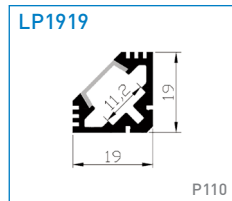
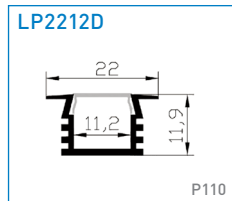
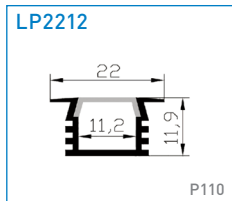
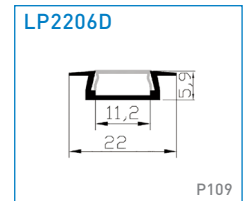
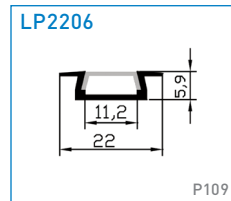
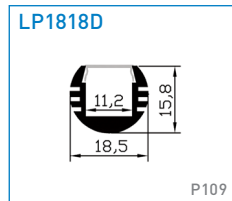
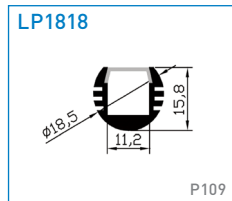
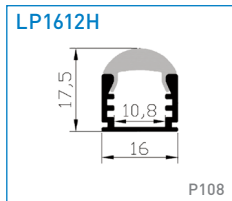

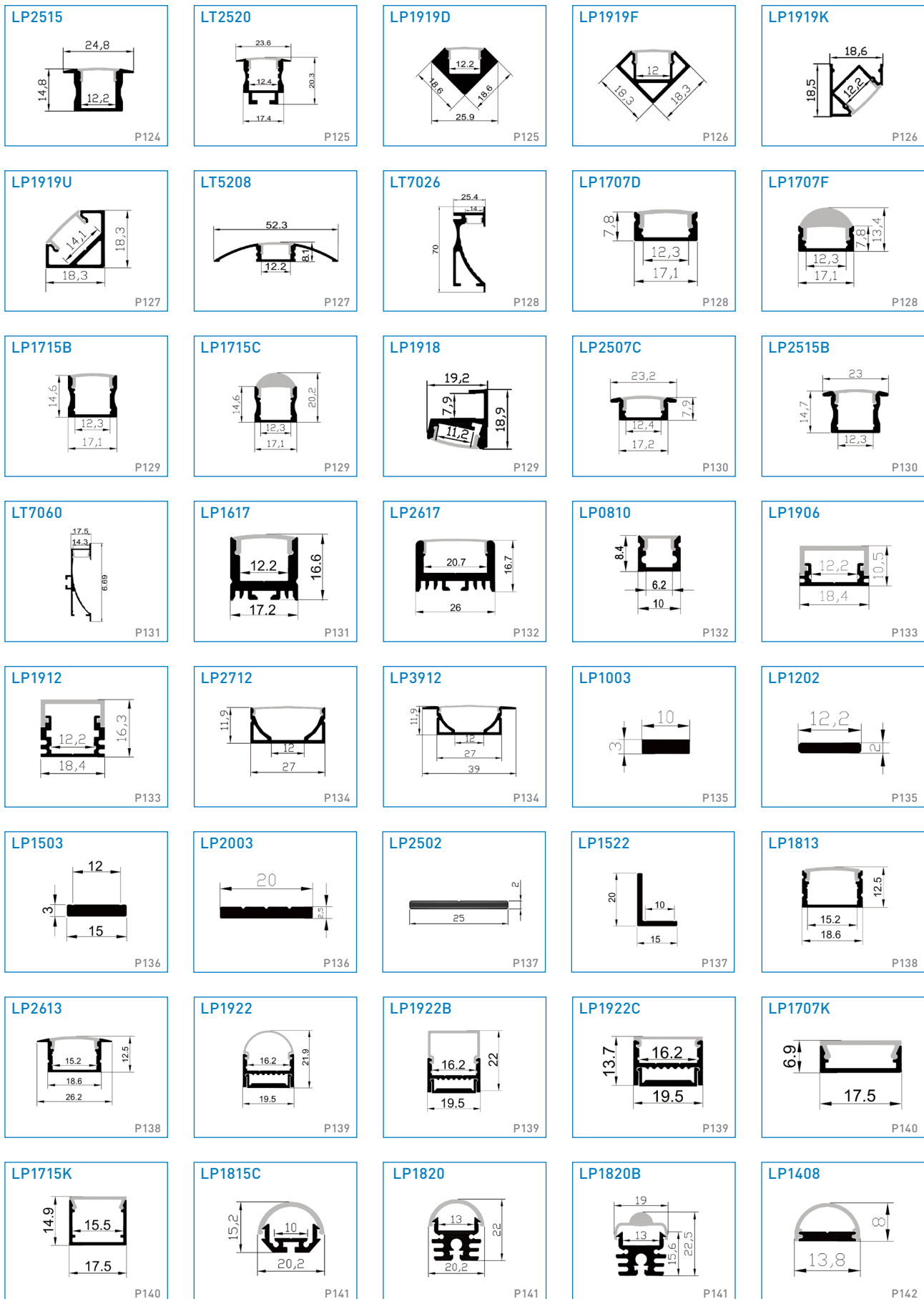

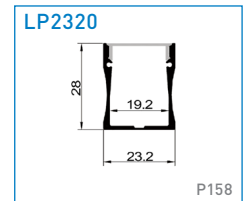
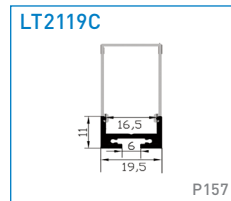
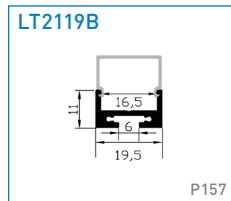
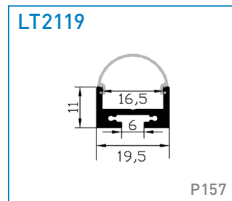
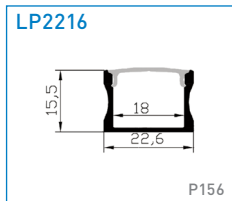
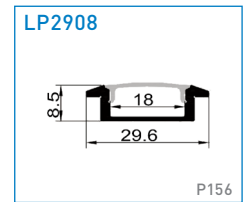
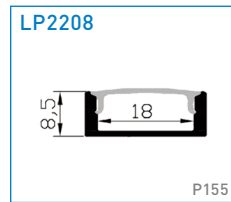
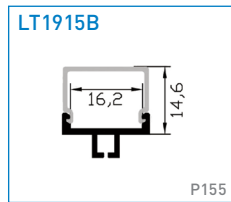
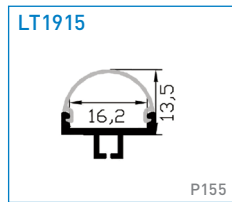
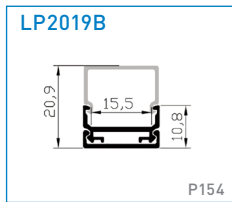
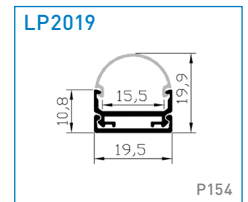
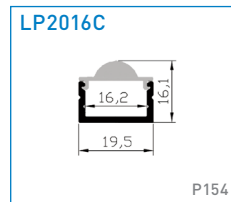
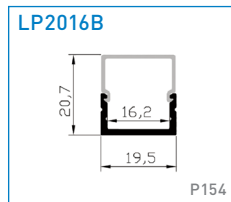
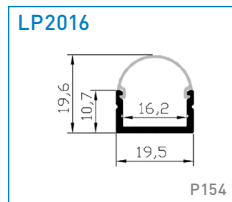
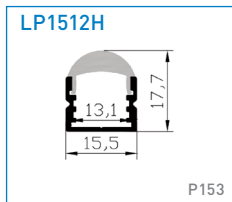
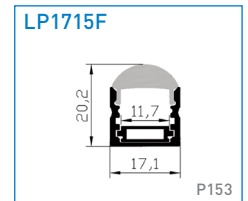
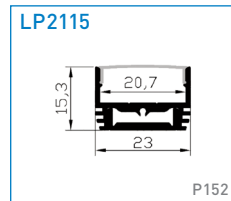
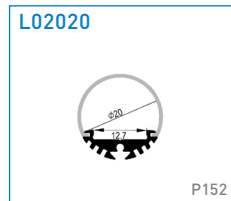
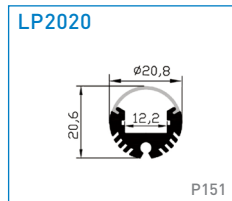
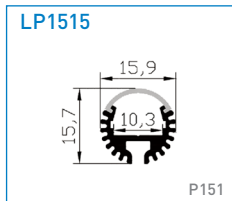
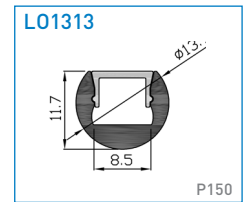
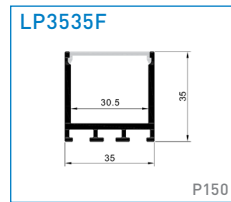
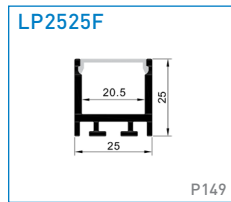
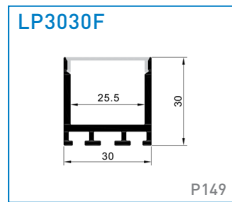
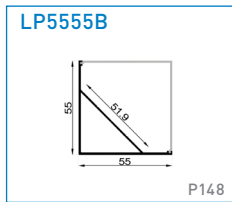
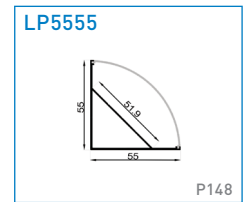
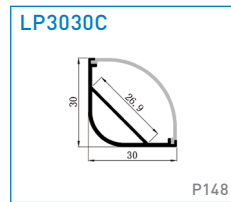
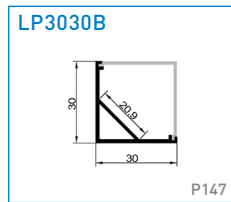
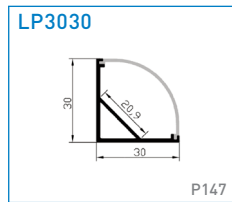
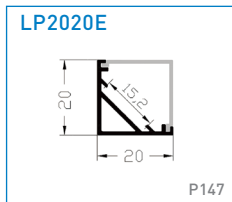
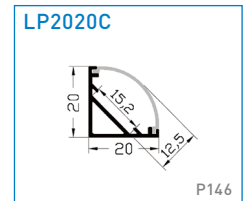
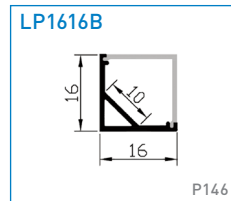
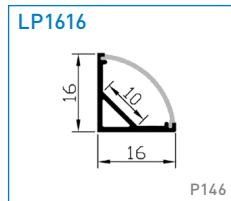
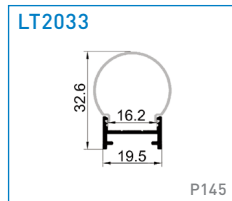
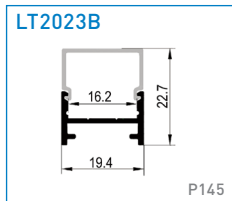
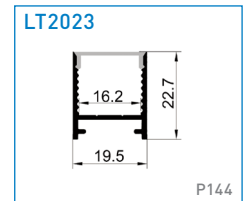
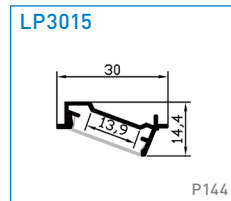
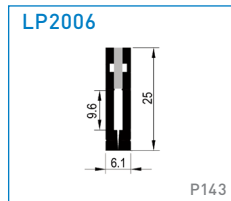
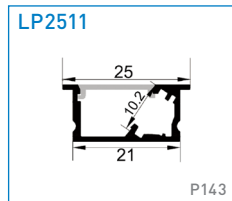
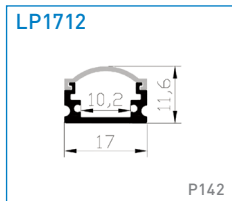

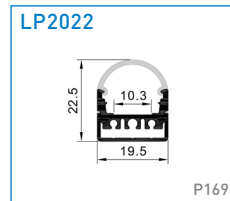
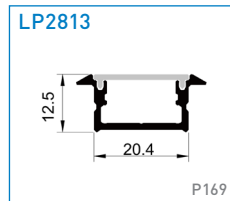
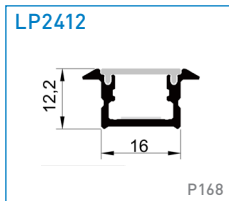
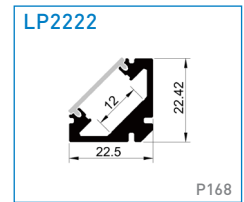
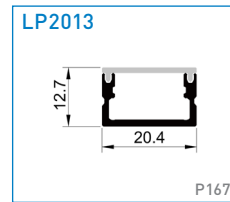
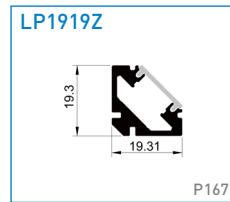
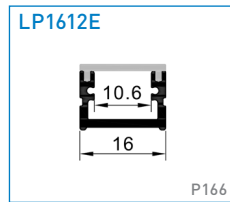
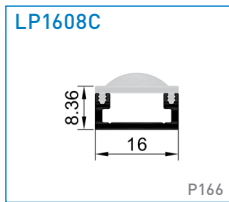
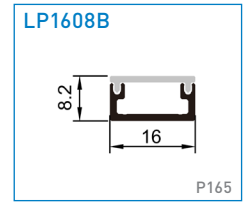
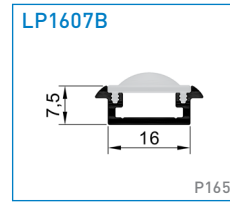
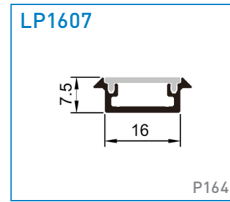
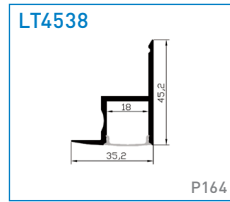
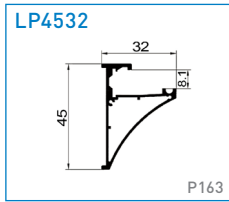
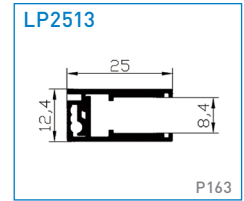
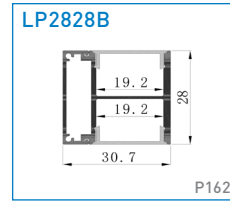
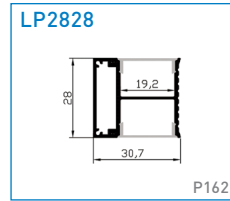
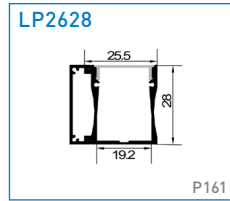
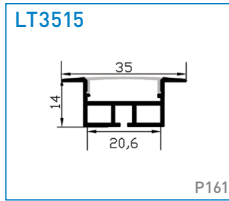
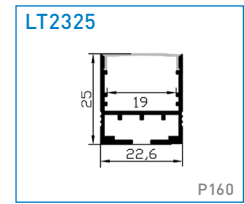
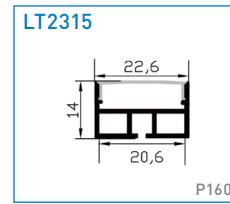
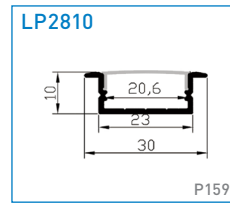
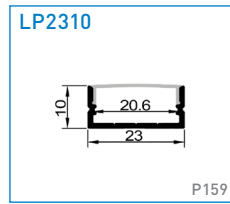
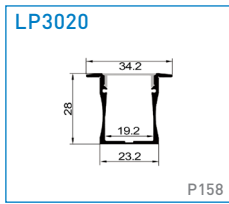

FREE ASSEMBLE PROFILE

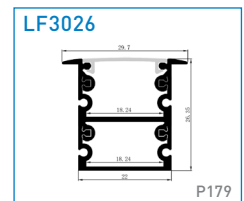
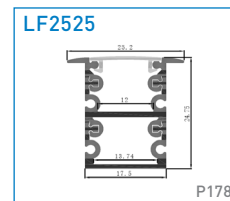
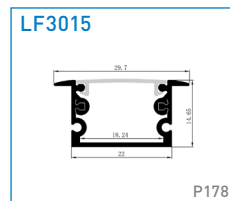
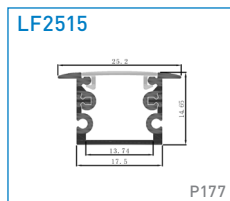
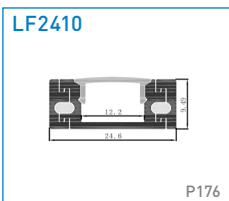
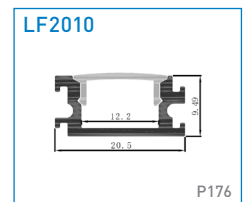
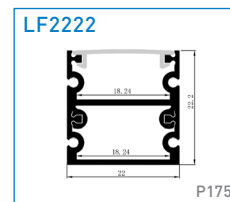
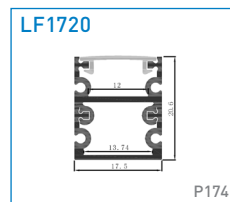
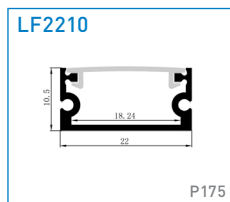
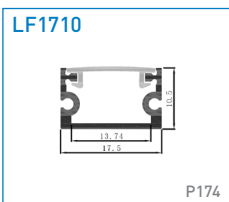

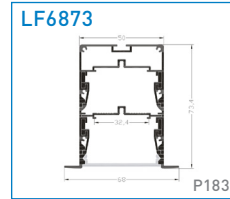
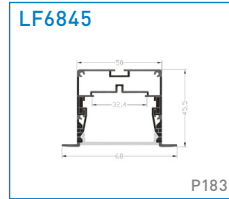
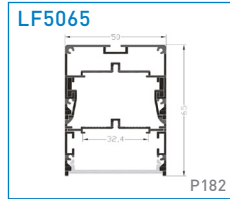
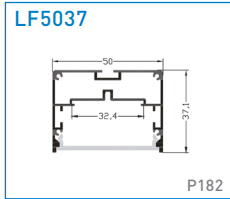
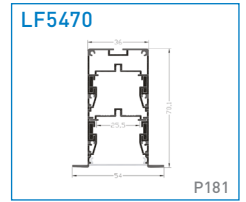
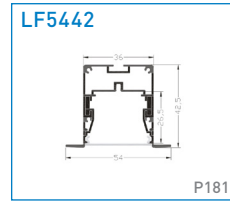
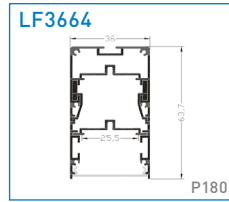
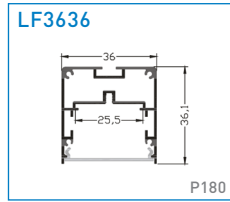
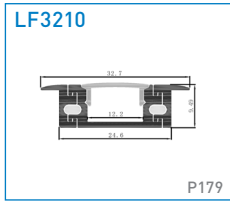

WATERPROOF PROFILE

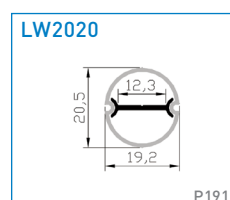
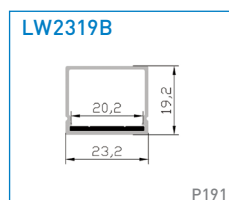
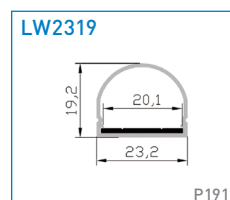
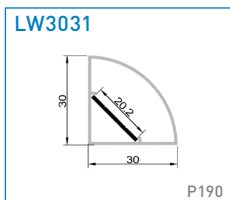
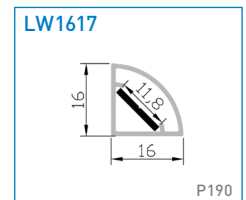
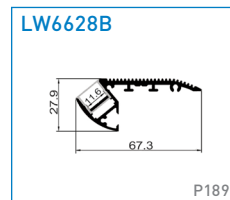
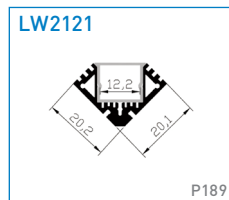
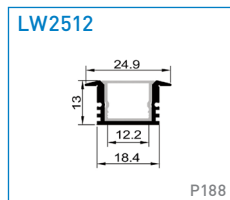
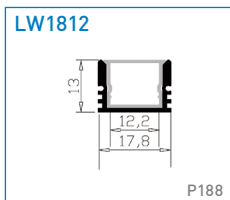
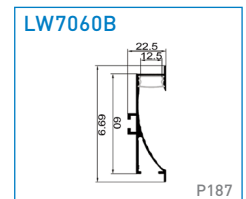
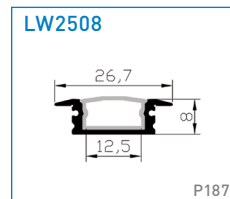
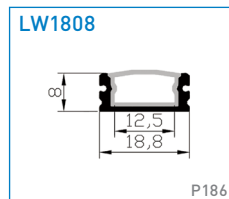
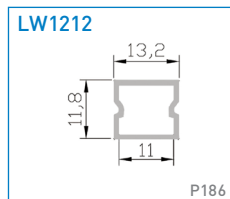
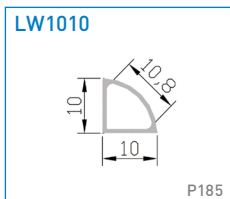

LINEAR PROFILE

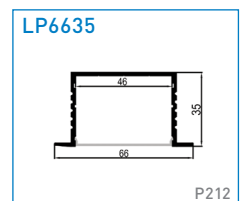
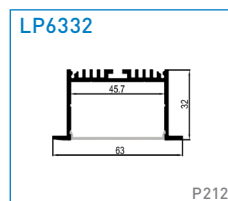
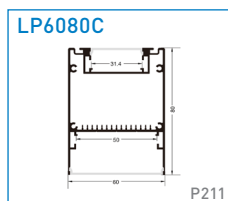
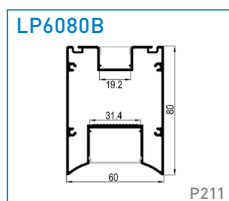
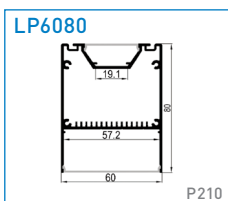
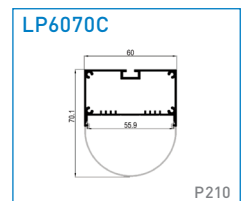
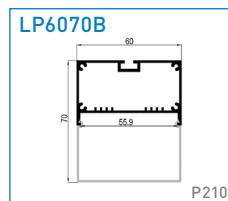
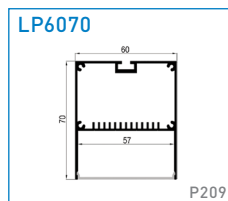
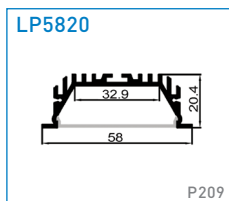
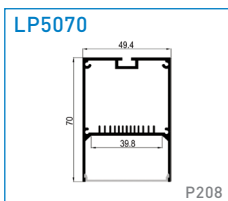
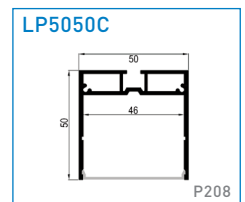
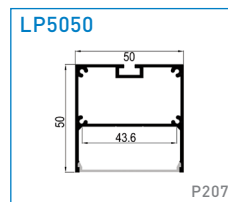
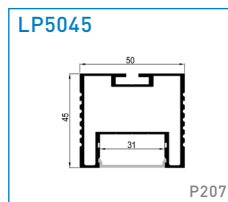
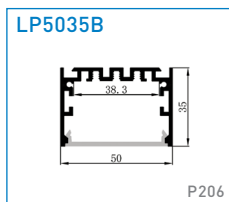
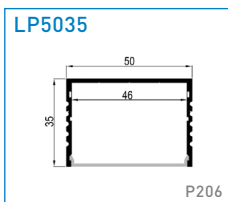
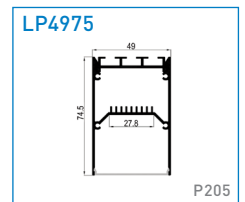
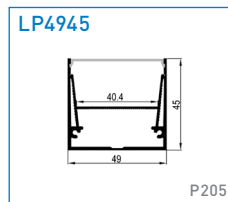
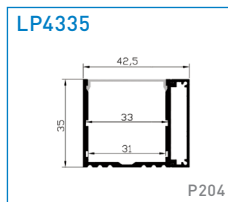
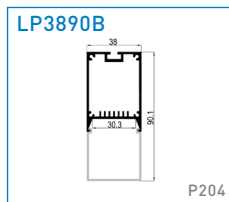
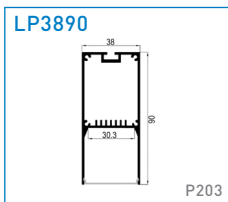
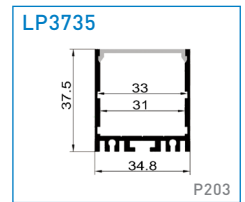
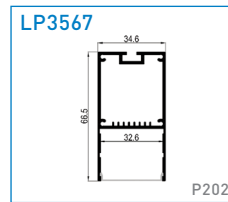
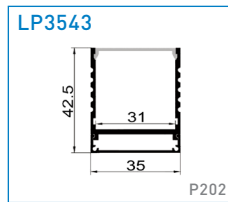
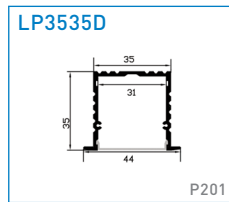
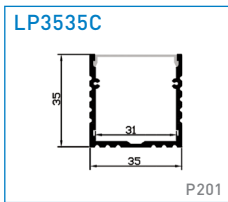
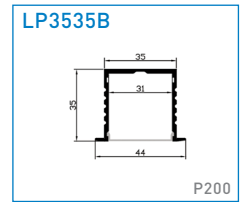
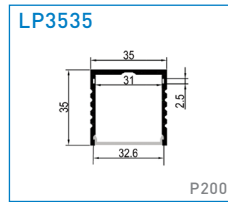
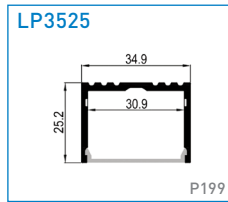
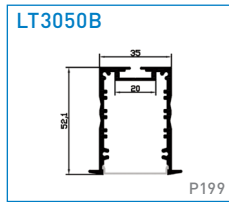
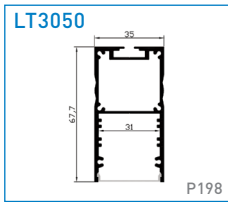
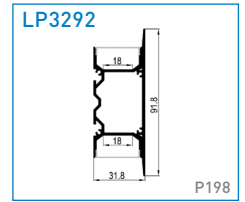
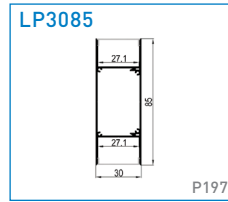
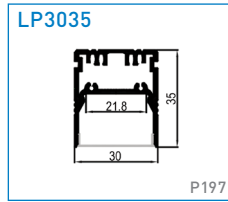
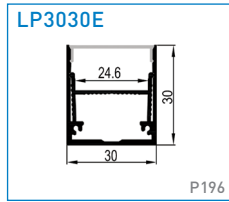
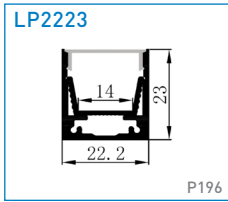

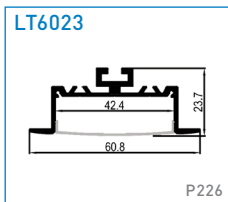
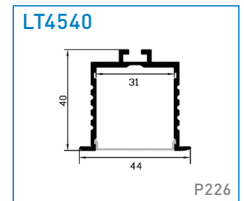
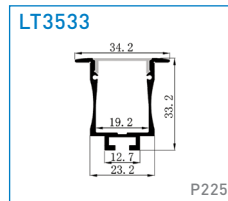
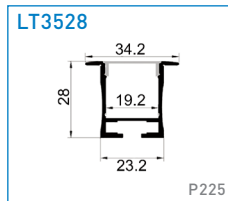
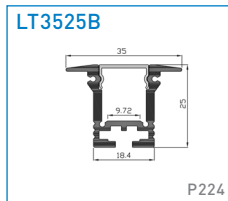
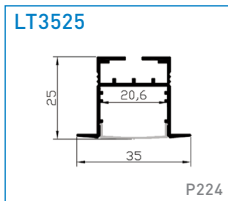
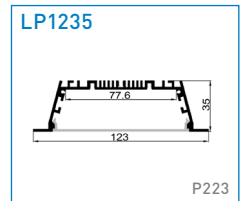
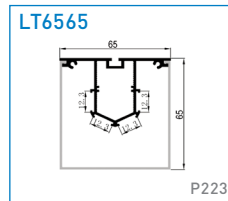
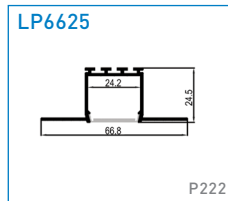
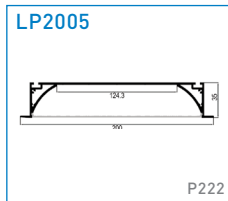
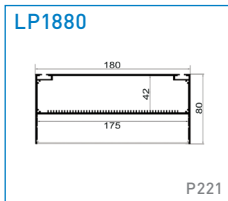
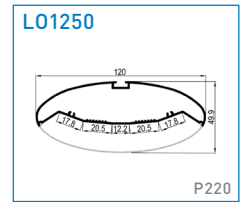
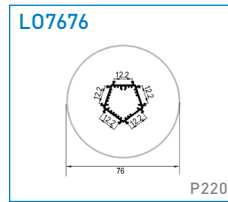
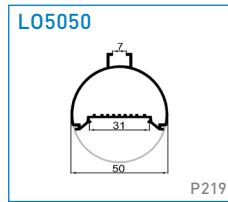
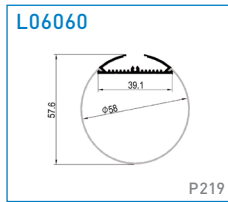
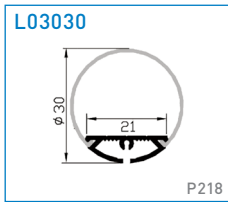
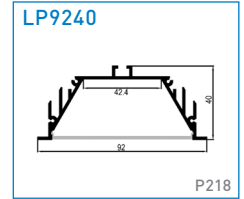
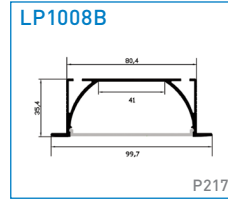
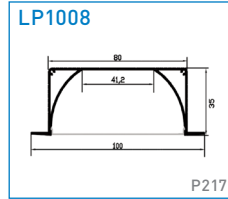
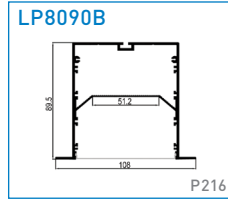
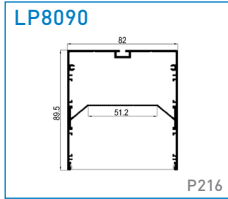
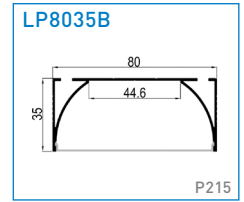
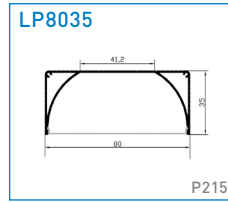
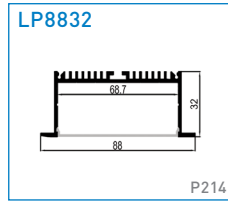
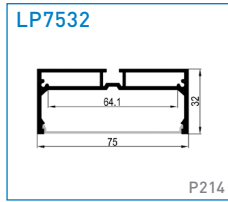
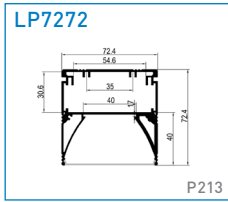

LED LINEAR LIGHTING

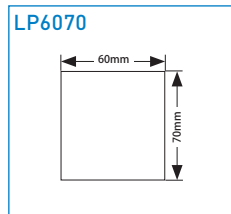
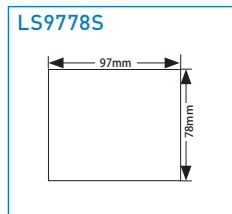
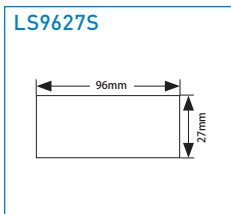
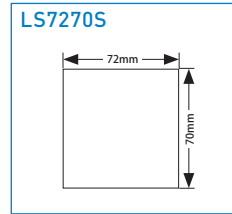
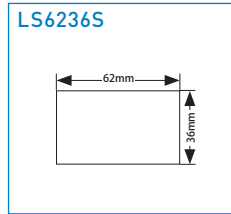
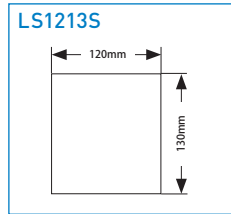
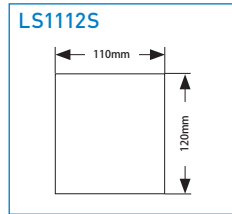
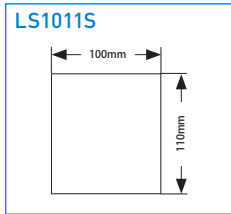
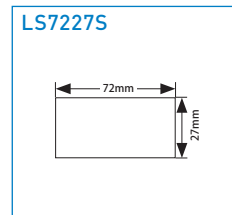
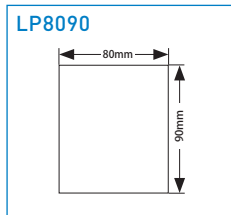
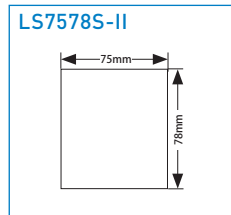
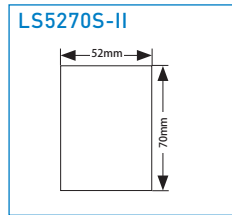
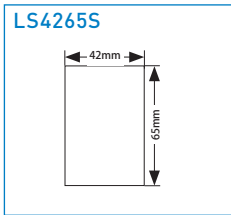

SMART LINEAR LIGHTING SYSTEM 2.0

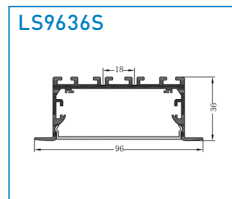
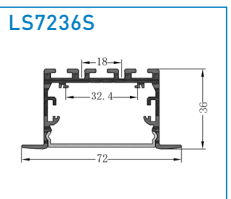
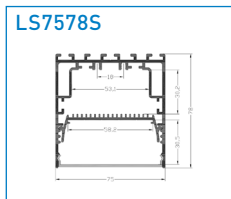
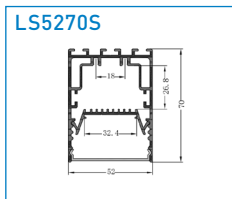
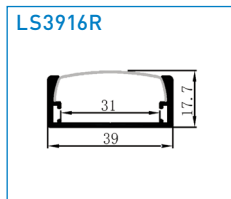
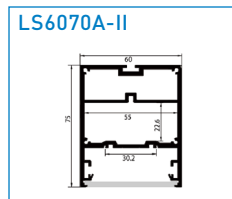
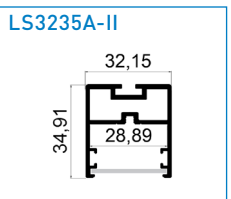
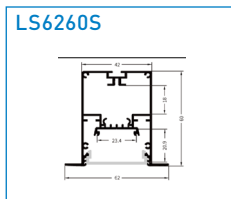
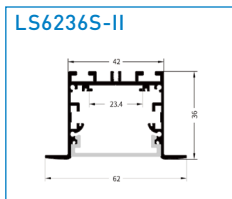
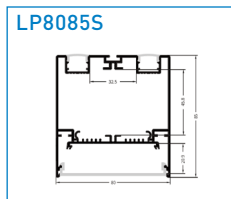
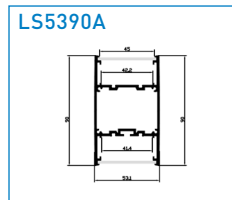
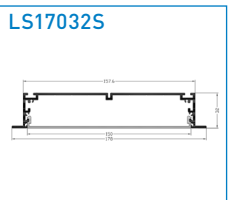
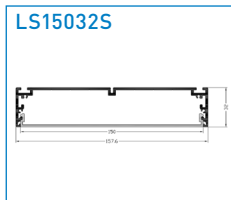
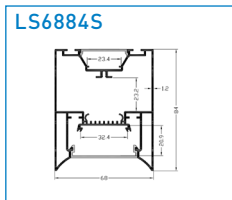
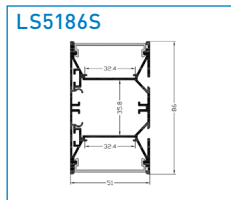

New LED Profile

The series of magnetic type products character is small volume , light weight, easy to move , with magnetic adsorption, which can be used as priming illumination , also as mobile illumination . Flexible and convenient , direction can be adjusted freely , effectively avoid lighting dead angle . which is applied to warehouse and specific needs for mechanical equipment illumination . The series of clips type are concealed inside of aluminum profile , overall design in beauty .



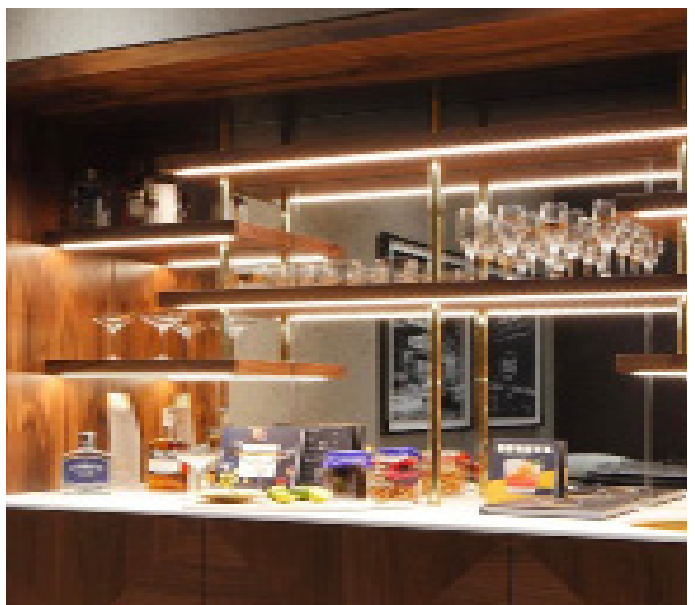

Creative Design Of Magnetic Installation

Convenient of installation

Convenient of movement

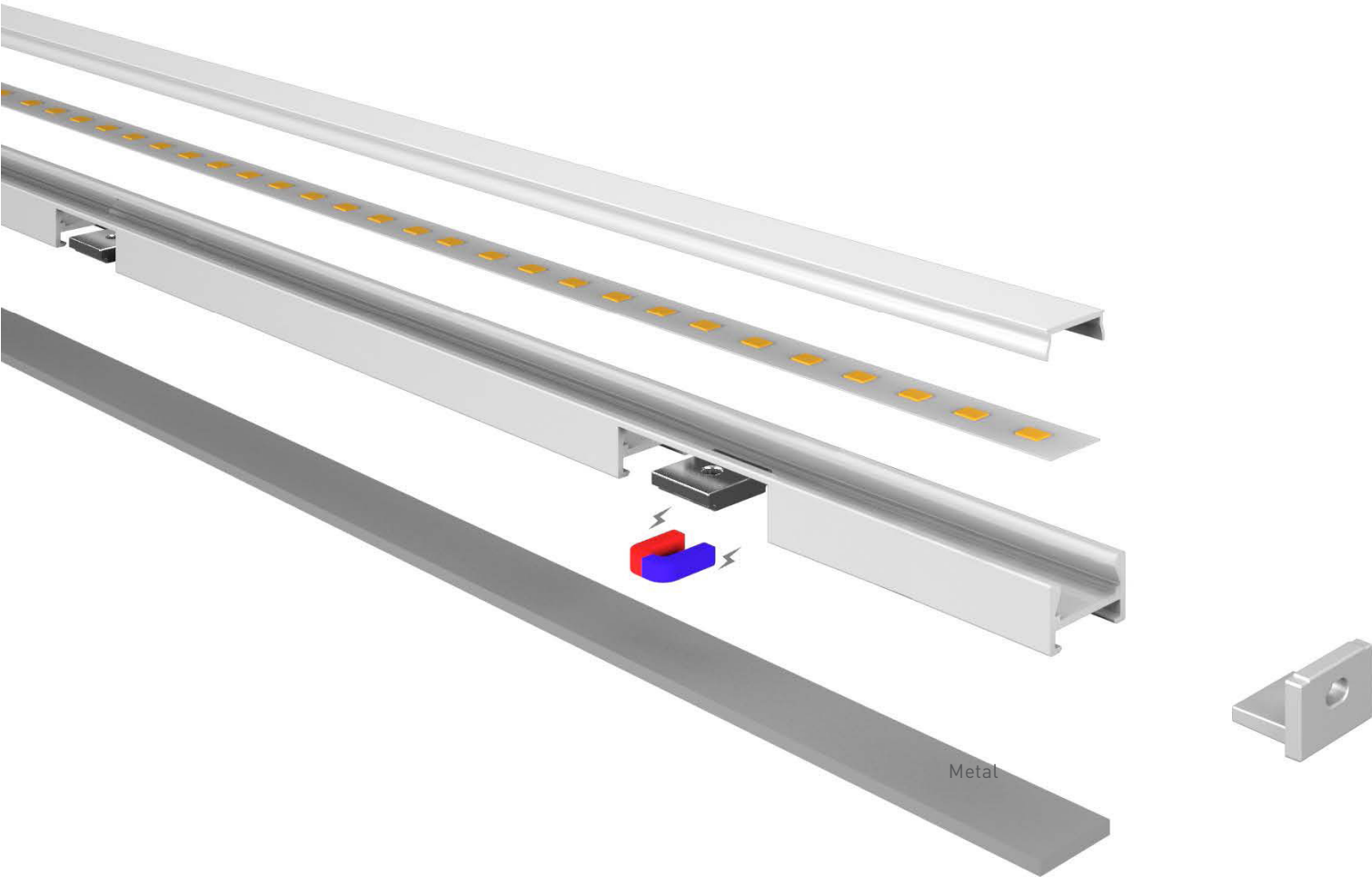

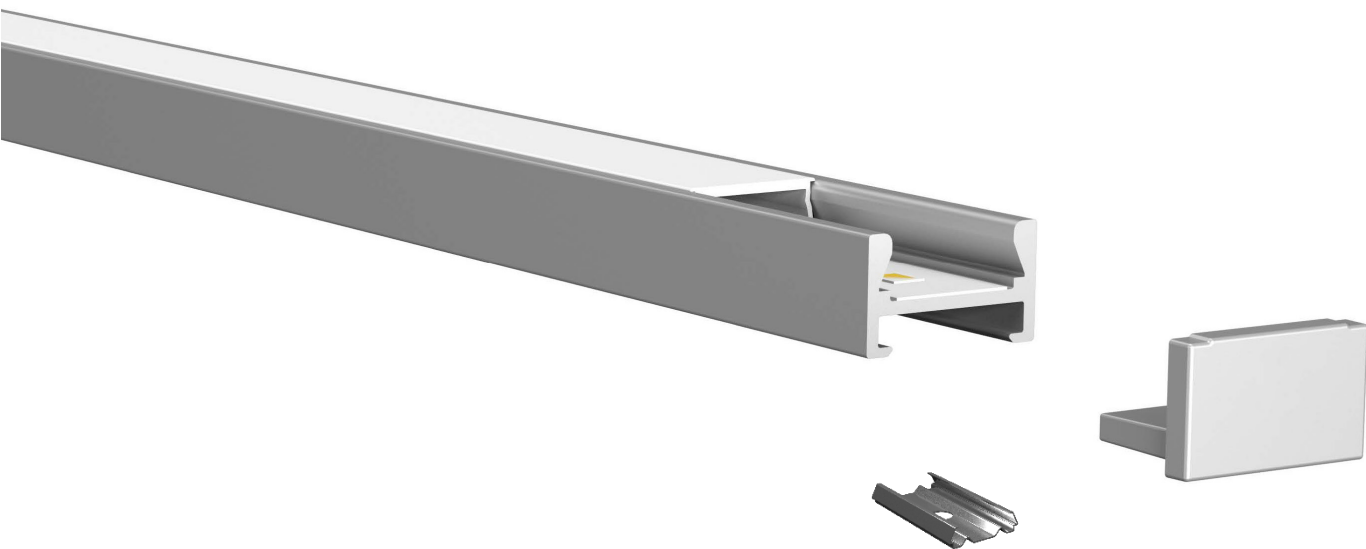

Creative Design Of Concealed Installation

Integrated design

Convenient of movement





LG1509

Magnetic installation

Invisible clip installation

NEW PROFILE

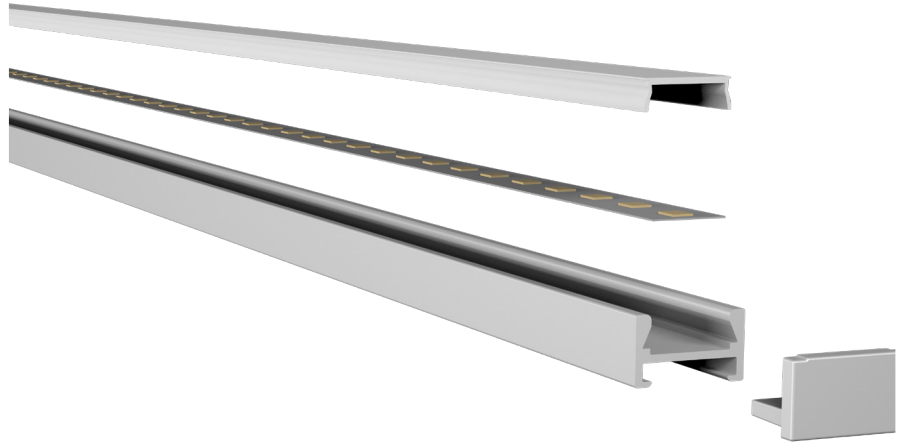

COVER



Trans:1506D2
Opal: 1506D3
Diffuser:1506D4

END CAP



Hole:15098
W/O hole: 15099

CLIP



15090

MAGNET



1509019

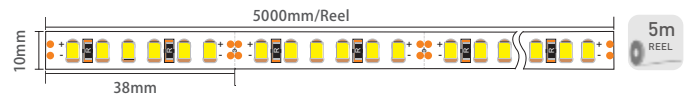

Silver
 Black
 White (ra9016)

Material:	AL6063-T5
Surface:	Anodized/ Painting
PC cover:	Diffuser /Transparent /Opal
Power:	14.4W/m
Input voltage:	24VDC
Lamp beads:	156LEDs/m (2835)
Lighting source width:	10 mm
Available lengths:	0.5-3m
Application:	Commercial lighting / Indoor lighting



Jane Eyre
Jane Eyre
Jane Eyre
Jane Eyre

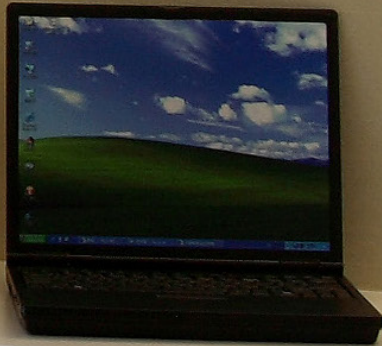



CE

IP20



LG1615

Magnetic installation

Invisible clip installation

NEW PROFILE



COVER

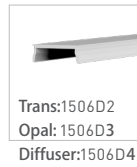

END CAP

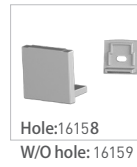

CLIP



MAGNET

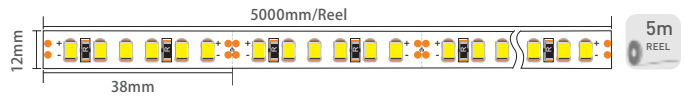

Silver
 Black
 White (ral9016)

Material:	AL6063-T5
Surface:	Anodized/ Painting
PC cover:	Diffuser /Transparent /Opal
Power:	14.4W/m
Input voltage:	24VDC
Lamp beads:	156LEDs/m (2835)
Lighting source width:	12mm
Available lengths:	0.5-3m
Application:	Commercial lighting / Indoor lighting

LG2209



Trans:1506D2
Opal: 1506D3
Diffuser:1506D4

COVER



Hole:22098
W/O hole: 22099

END CAP



15090

CLIP



1509019

MAGNET

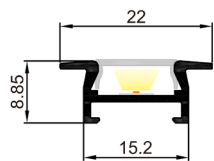

Material:	AL6063-T5
Surface:	Anodized/ Painting
PC cover:	Diffuser /Transparent /Opal
Power:	14.4W/m
Input voltage:	24VDC
Lamp beads:	156LEDs/m (2835)
Lighting source width:	12mm
Available lengths:	0.5-3m
Application:	Commercial lighting / Indoor lighting





LG2315

NEW PROFILE



COVER	Trans:1506D2 Opal: 1506D3 Diffuser:1506D4	
END CAP	Hole:23158 W/O hole: 23159	
CLIP	15090	
MAGNET	1509019	



- Silver
- Black
- White (RAL9016)

Material:	AL6063-T5
Surface:	Anodized/ Painting
PC cover:	Diffuser /Transparent /Opal
Power:	14.4W/m
Input voltage:	24VDC
Lamp beads:	156LEDs/m (2835)
Lighting source width:	12 mm
Available lengths:	0.5-3m
Application:	Commercial lighting / Indoor lighting

LG1710

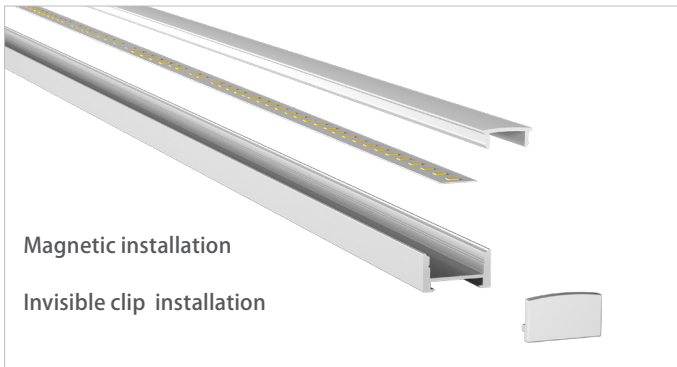

COVER



Trans:17072
Opal: 17073
Diffuser:17074

END CAP



Hole:17108
W/O hole: 17109

CLIP



15090

MAGNET



1509019

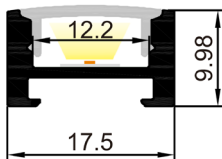

- Silver
- Black
- White (ral9016)

Material:	AL6063-T5
Surface:	Anodized/ Painting
PC cover:	Diffuser /Transparent /Opal
Power:	14.4W/m
Input voltage:	24VDC
Lamp beads:	156LEDs/m (2835)
Lighting source width:	10 mm
Available lengths:	0.5-3m
Application:	Commercial lighting / Indoor lighting





CE

IP20



LG1716

NEW PROFILE



COVER

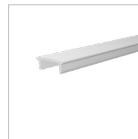

Trans:17072
Opal: 17073
Diffuser:17074

END CAP



Hole:17168
W/O hole: 17169

CLIP



15090

MAGNET



1509019



Silver
 Black
 White (RAL9016)

Material:	AL6063-T5
Surface:	Anodized/ Painting
PC cover:	Diffuser /Transparent /Opal
Power:	14.4W/m
Input voltage:	24VDC
Lamp beads:	156LEDs/m (2835)
Lighting source width:	10 mm
Available lengths:	0.5-3m
Application:	Commercial lighting / Indoor lighting

LG2410





Magnetic installation
Invisible clip installation



- Silver
- Black
- White (RAL9016)

Material:	AL6063-T5
Surface:	Anodized/ Painting
PC cover:	Diffuser /Transparent /Opal
Power:	14.4W/m
Input voltage:	24VDC
Lamp beads:	156LEDs/m (2835)
Lighting source width:	10 mm
Available lengths:	0.5-3m
Application:	Commercial lighting / Indoor lighting

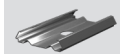
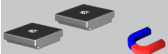

	Trans:17072 Opal: 17073 Diffuser:17074	COVER
	Hole:24108 W/O hole: 24109	END CAP
	15090	CLIP
	1509019	MAGNET

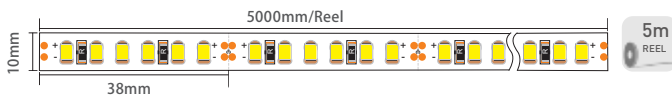
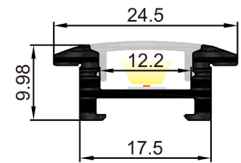



Magnetic installation
Invisible clip installation





LG2416

 Silver  Black  White (RAL9016)

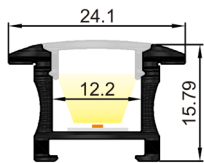

Material:	AL6063-T5
Surface:	Anodized/ Painting
PC cover:	Diffuser /Transparent /Opal
Power:	14.4W/m
Input voltage:	24VDC
Lamp beads:	156LEDs/m (2835)
Lighting source width:	10 mm
Available lengths:	0.5-3m
Application:	Commercial lighting / Indoor lighting



Trans:17072 Opal: 17073 Diffuser:17074	COVER	
--	-------	---

Hole:24168 W/O hole: 24169	END CAP	
-------------------------------	---------	---

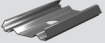
15090	CLIP	
-------	------	--

1509019	MAGNET	
---------	--------	---

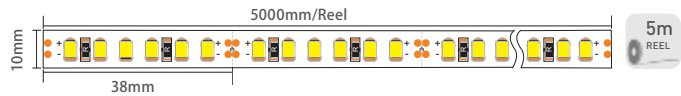

LG3012



Material:	AL6063-T5
Surface:	Anodized/ Painting
PC cover:	Diffuser /Transparent /Opal
Power:	14.4W/m
Input voltage:	24VDC
Lamp beads:	156LEDs/m (2835)
Lighting source width:	16 mm
Available lengths:	0.5-3m
Application:	Commercial lighting / Indoor lighting

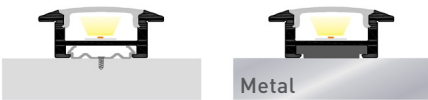
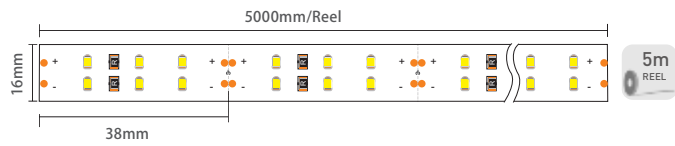
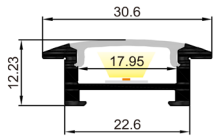

Metal

COVER

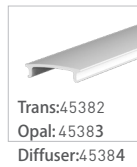

END CAP



CLIP



MAGNET

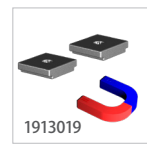

LG2212



NEW PROFILE

Material:	AL6063-T5
Surface:	Anodized/ Painting
PC cover:	Diffuser /Transparent /Opal
Power:	14.4W/m
Input voltage:	24VDC
Lamp beads:	156LEDs/m (2835)
Lighting source width:	16 mm
Available lengths:	0.5-3m
Application:	Commercial lighting / Indoor lighting

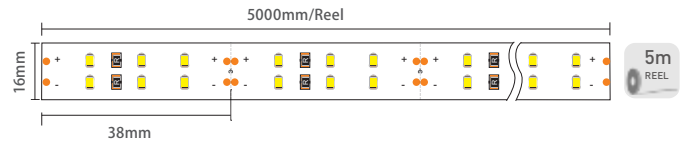
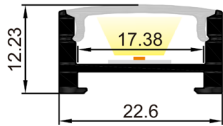

COVER

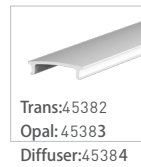

END CAP



CLIP



MAGNET

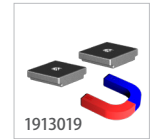

LG3017 NEW

CE IP20

Material:	AL6063-T5
Surface:	Anodized/ Painting
PC cover:	Diffuser /Transparent /Opal
Power:	14.4W/m
Input voltage:	24VDC
Lamp beads:	156LEDs/m (2835)
Lighting source width:	16 mm
Available lengths:	0.5-3m
Application:	Commercial lighting / Indoor lighting

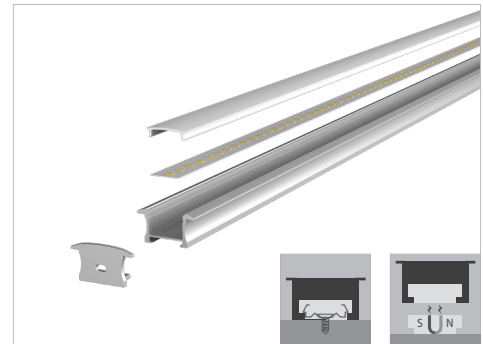

Silver
 Black
 White (ral9016)

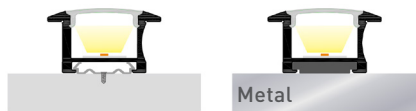
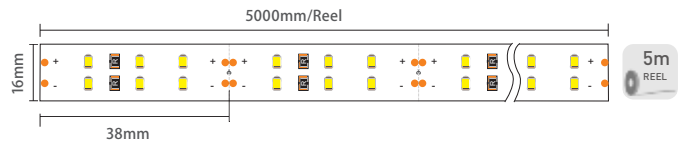
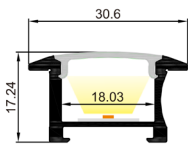

COVER

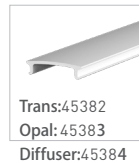

END CAP



CLIP



MAGNET

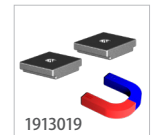

LG2217 NEW

CE IP20

Material:	AL6063-T5
Surface:	Anodized/ Painting
PC cover:	Diffuser /Transparent /Opal
Power:	14.4W/m
Input voltage:	24VDC
Lamp beads:	156LEDs/m (2835)
Lighting source width:	16 mm
Available lengths:	0.5-3m
Application:	Commercial lighting / Indoor lighting



Silver
 Black
 White (ral9016)

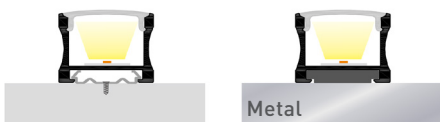
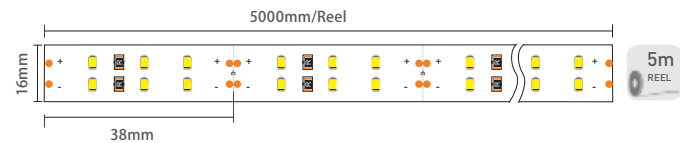
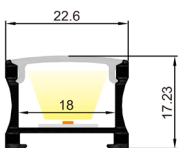

COVER

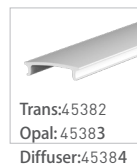

END CAP



CLIP



MAGNET

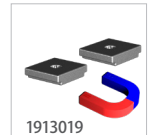

LG1913 NEW

CE IP20

Material:	AL6063-T5
Surface:	Anodized/ Painting
PC cover:	Diffuser /Transparent /Opal
Power:	14.4W/m
Input voltage:	24VDC
Lamp beads:	156LEDs/m (2835)
Lighting source width:	16 mm
Available lengths:	0.5-3m
Application:	Commercial lighting / Indoor lighting

Silver
 Black
 White (RAL9016)

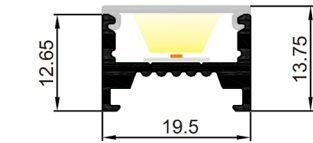

COVER



END CAP



CLIP



MAGNET

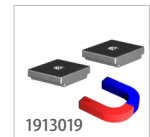

LG2020 NEW

CE IP20

Material:	AL6063-T5
Surface:	Anodized/ Painting
PC cover:	Diffuser /Transparent /Opal
Power:	14.4W/m
Input voltage:	24VDC
Lamp beads:	156LEDs/m (2835)
Lighting source width:	10 mm
Available lengths:	0.5-3m
Application:	Commercial lighting / Indoor lighting

Silver
 Black
 White (RAL9016)

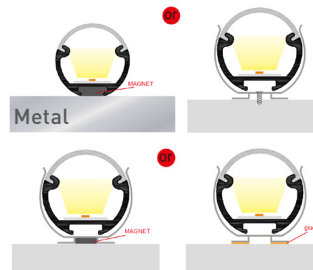
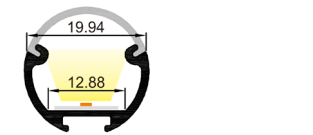

COVER

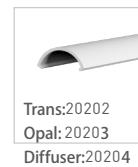

END CAP



MAGNET



CLIP



MAGNET



LG1618/LG1618B ^{NEW}



Material:	AL6063-T5
Surface:	Anodized/ Painting
PC cover:	Diffuser /Transparent /Opal
Power:	14.4W/m
Input voltage:	24VDC
Lamp beads:	156LEDs/m (2835)
Lighting source width:	10 mm
Available lengths:	0.5-3m
Application:	Commercial lighting / Indoor lighting

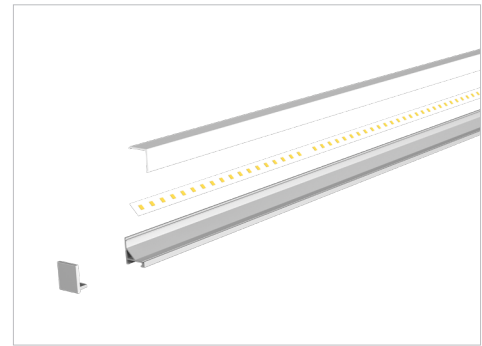

LG1618

LG1618B

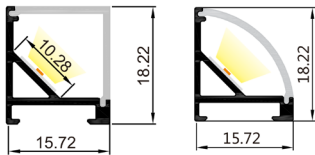

LG1618



COVER

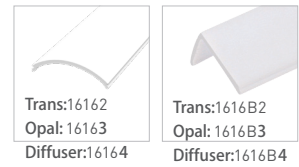

END CAP



CLIP



MAGNET



LG3131/LG3131B ^{NEW}



Material:	AL6063-T5
Surface:	Anodized/ Painting
PC cover:	Diffuser /Transparent /Opal
Power:	14.4W/m
Input voltage:	24VDC
Lamp beads:	156LEDs/m (2835)
Lighting source width:	18 mm
Available lengths:	0.5-3m
Application:	Commercial lighting / Indoor lighting

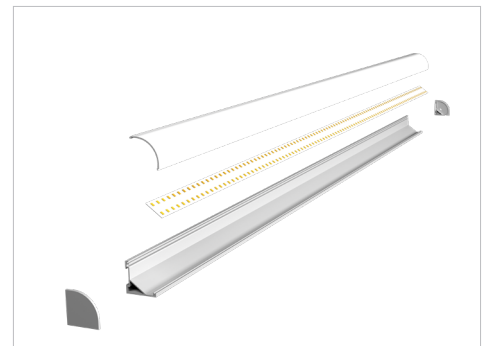
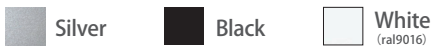

LG3131

LG3131B

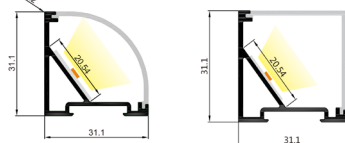

LG3131

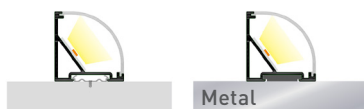

COVER

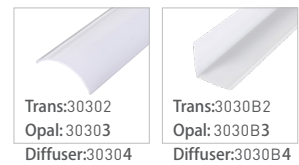

END CAP

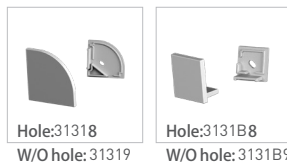

CLIP



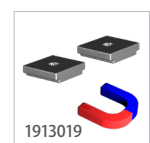

MAGNET



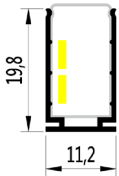



LN1120 NEW

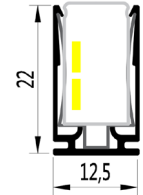
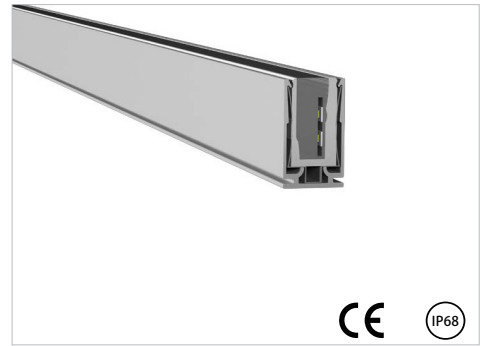

 Silver	 Black	 White <small>(RAL9016)</small>
Material: AL6063-T5		
Surface: Anodized/ Painting		
cover: Diffuser /Transparent /Opal		
Power: 14.4W/m		
Input voltage: 24VDC		
Lamp beads: 156LEDs/m (2835)		
Lighting source width: 8 mm		
Available lengths: 0.5-3m		
Application: Commercial lighting / Indoor lighting		

LN1322 NEW



 Silver	 Black	 White <small>(RAL9016)</small>
Material: AL6063-T5		
Surface: Anodized/ Painting		
PC cover: Diffuser /Transparent /Opal		
Power: 14.4W/m		
Input voltage: 24VDC		
Lamp beads: 156LEDs/m (2835)		
Lighting source width: 8 mm		
Available lengths: 0.5-3m		
Application: Commercial lighting / Indoor lighting		



Other model:

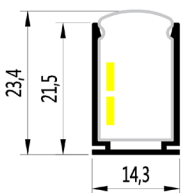

LN1422

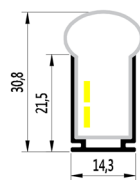

LN1422C

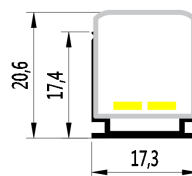

LN1717

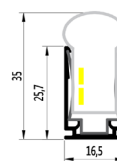

LN1726

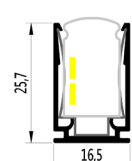

LN1726B

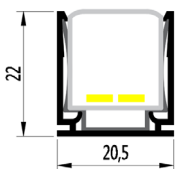

LN2122

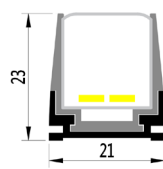

LN2123



MINI LED Profile

The series of mini type products character is Minisize , narrow luminous surface , which can gives off ultrafine dazzle light .Give you a different visual experience Less heat, high luminous efficiency, energy - saving and environmental protection. It also protects your vision.

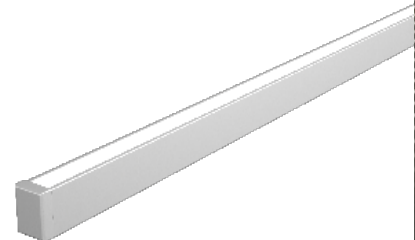

Extremely narrow
light-emitting area
Only 4mm



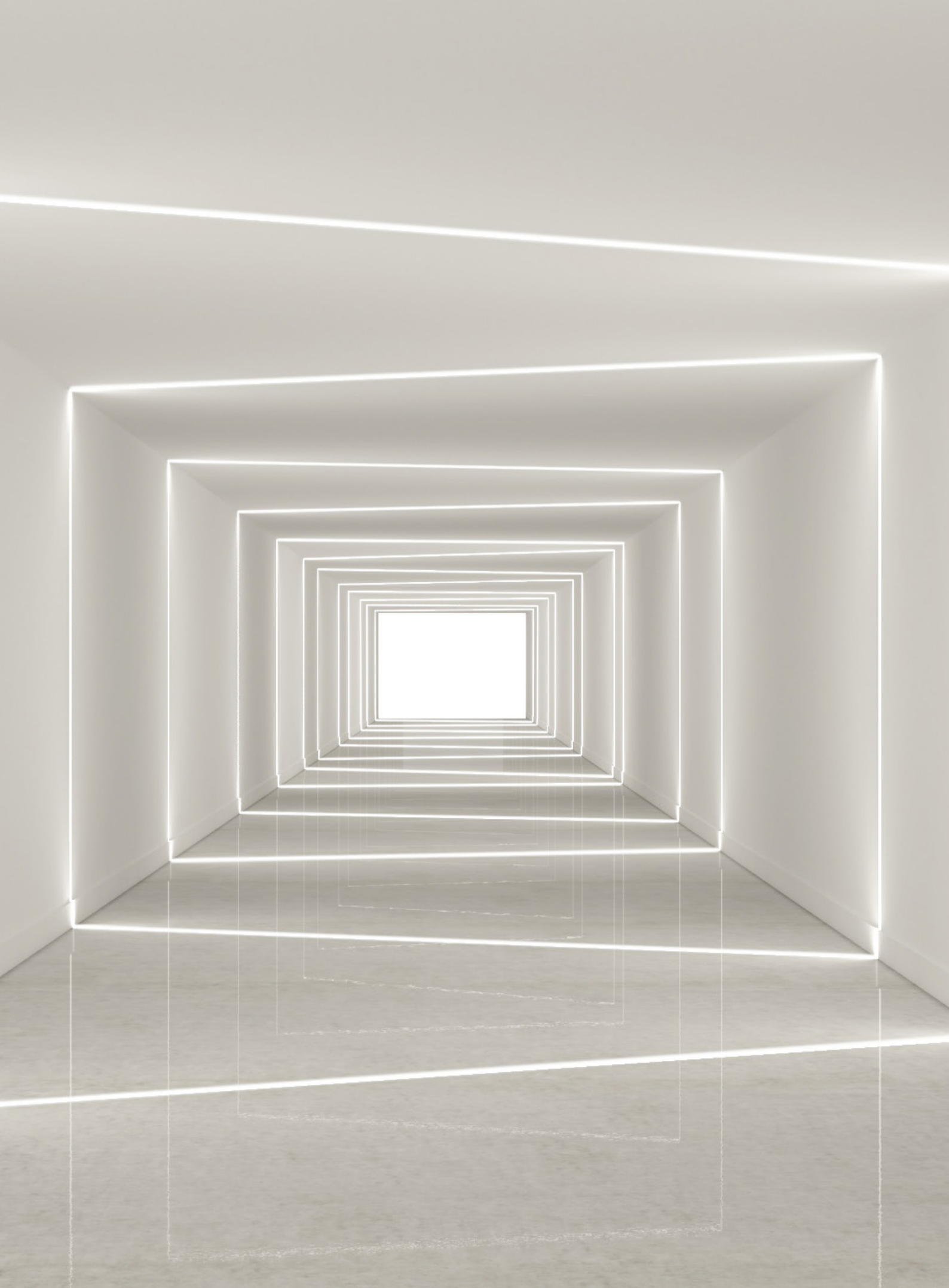

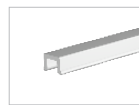
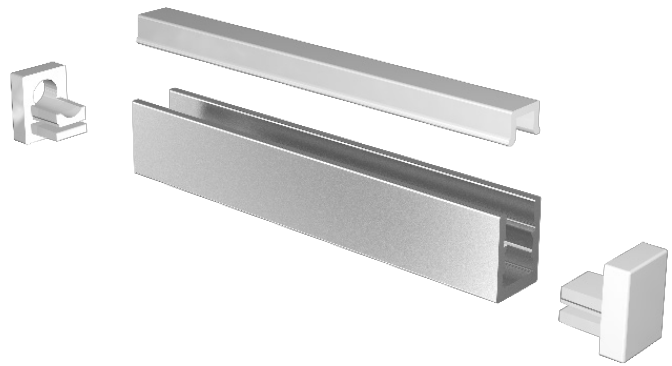

COVER

Trans:05072
Opal:05073
Diffuser:05074



END CAP

Hole:05078
W/O hole:05079



CLIP

LP05070

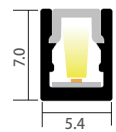
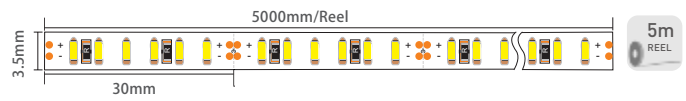

- Silver
- Black
- White (RAL9016)

Material:	AL6063-T5
Surface:	Anodized/ Painting
PC cover:	Diffuser /Transparent /Opal
Power:	7.2W/m
Input voltage:	24VDC
Lamp beads:	198LEDs/m [3014]
Lighting source width:	3.5 mm
Available lengths:	0.5-3m
Application:	Commercial lighting / Indoor lighting

LP0510 NEW



Material:	AL6063-T5
Surface:	Anodized/ Painting
PC cover:	Diffuser/Transparent/Opal
Power:	10W/m
Input voltage:	24VDC
Lamp beads:	156LEDs/m (3014)
Lighting source width:	3.5mm
Available lengths:	0.5-3m
Application:	Commercial lighting / Indoor lighting

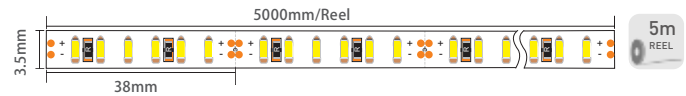
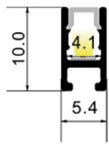
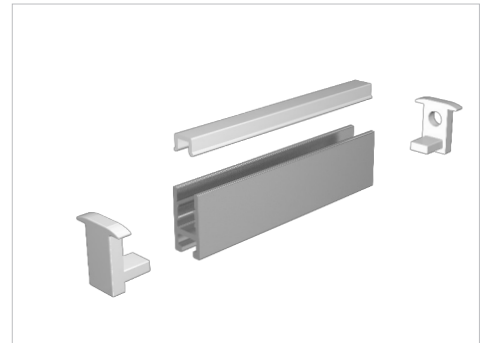

COVER

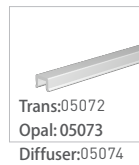

END CAP



CONNECTOR



LP0907 NEW



Material:	AL6063-T5
Surface:	Anodized/ Painting
PC cover:	Diffuser/Transparent/Opal
Power:	7.2W/m
Input voltage:	24VDC
Lamp beads:	198LEDs/m (3014)
Lighting source width:	3.5mm
Available lengths:	0.5-3m
Application:	Commercial lighting / Indoor lighting

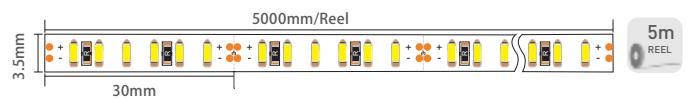
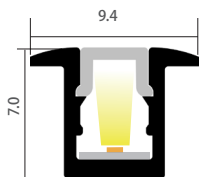
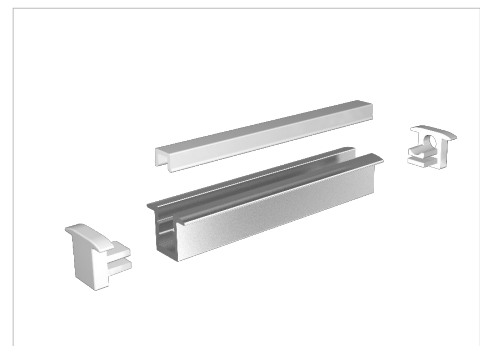

COVER

Trans:05072
Opal: 05073
Diffuser:05074



END CAP

Hole:09078
W/O hole: 09079



LP0910 NEW



Material:	AL6063-T5
Surface:	Anodized/ Painting
PC cover:	Diffuser /Transparent /Opal
Power:	10W/m
Input voltage:	24VDC
Lamp beads:	156LEDs/m (3014)
Lighting source width:	3.5 mm
Available lengths:	0.5-3m
Application:	Commercial lighting / Indoor lighting

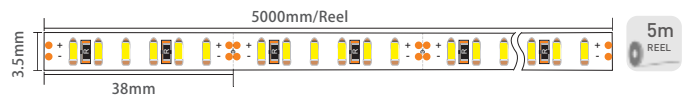
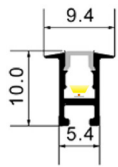
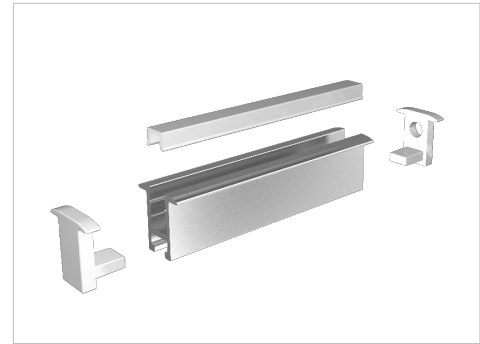

COVER

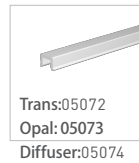

END CAP



CONNECTOR



LP1010C NEW



Material:	AL6063-T5
Surface:	Anodized/ Painting
PC cover:	Diffuser /Transparent /Opal
Power:	14.4W/m
Input voltage:	24VDC
Lamp beads:	198LEDs/m (2835)
Lighting source width:	6 mm
Available lengths:	0.5-3m
Application:	Commercial lighting / Indoor lighting

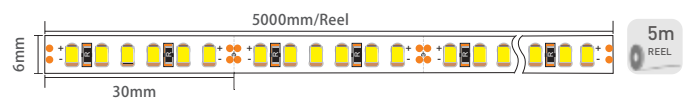
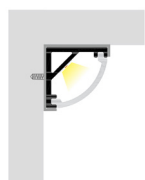
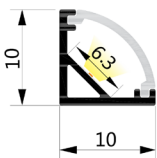

COVER

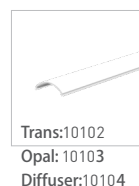

END CAP



OTHERS





Bendable LED Profile

Large range multi-size adjustable (Products bend size width 10mm to 49mm;high 1mm to 15mm;length unlimited) ,
Easy to handle and convenient to carry, Any arc, round, "S" shape, wave shape can be bendable,Omnidirectional personalized customization LED profile, Manual operation without power supply.

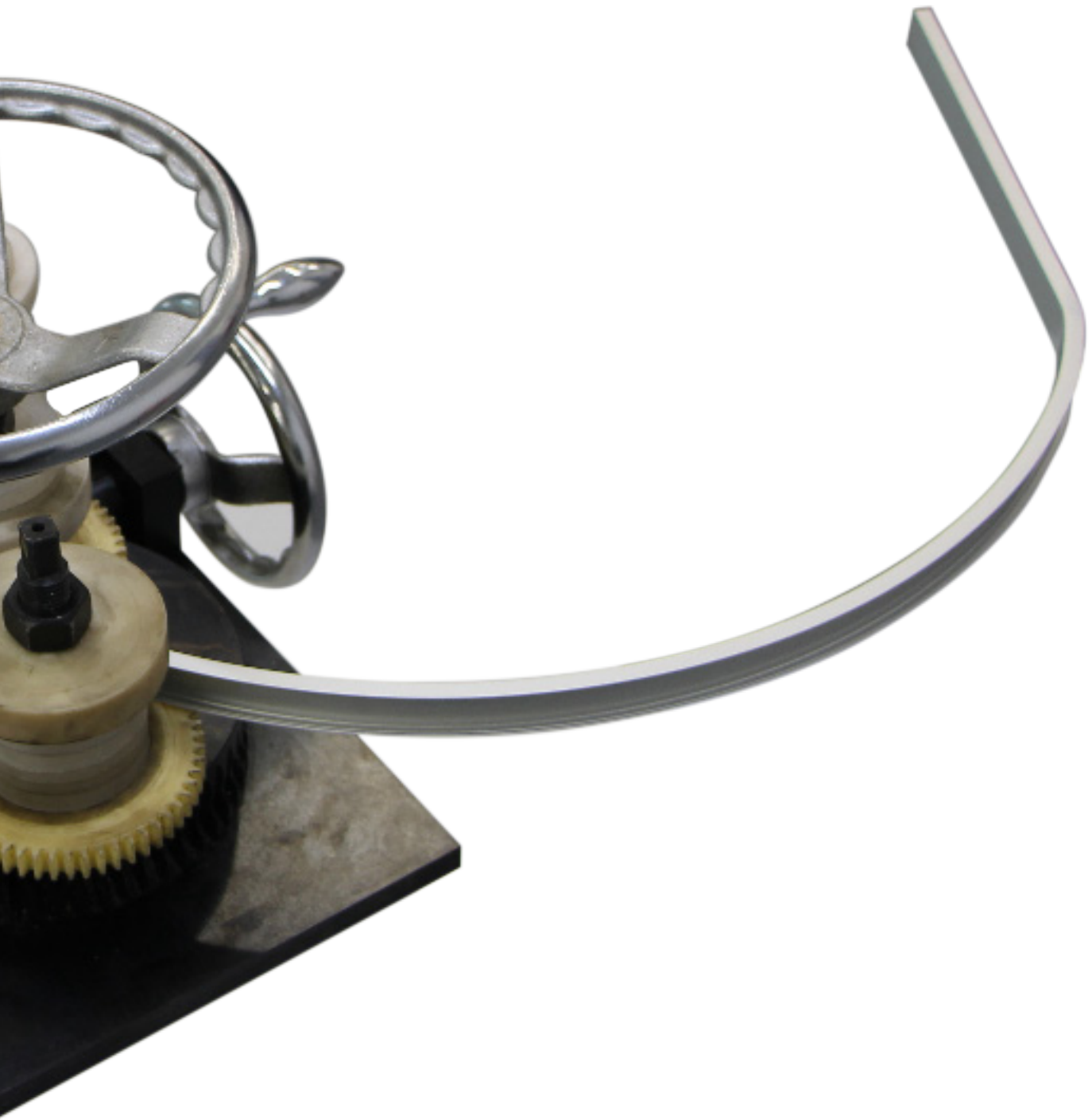



LP220



LP2208-R

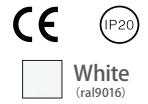

Silver
 Black
 White (RAL9016)



Material:	AL6063-T5
Surface:	Anodized/ Painting
PC cover:	Diffuser /Transparent /Opal
Power:	14.4W/m
Input voltage:	24VDC
Lamp beads:	120LEDs/m (2835)
Lighting source width:	10 mm
Available lengths:	0.5-3m
Application:	Commercial lighting / Indoor lighting Decorative design

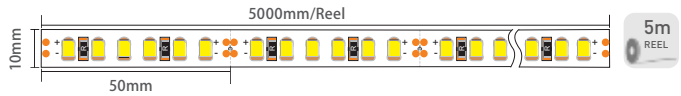

COVER



Trans :45382
 Opal: 45383
 Diffuser :45384

END CAP



Hole:22088
 W/O hole:22089

CLIP



220802

CONNECTOR



1707D017

Bending step

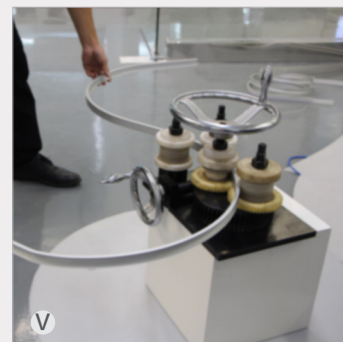
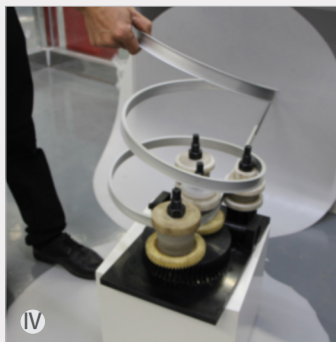

LP1707K-R



Silver	Black	White <small>(ra19016)</small>
Material:	AL6063-T5	
Surface:	Anodized/ Painting	
PC cover:	Diffuser /Transparent /Opal	
Power:	14.4W/m	
Input voltage:	24VDC	
Lamp beads:	120LEDs/m (2835)	
Lighting source width:	10 mm	
Available lengths:	0.5-3m	
Application:	Commercial lighting / Indoor lighting	

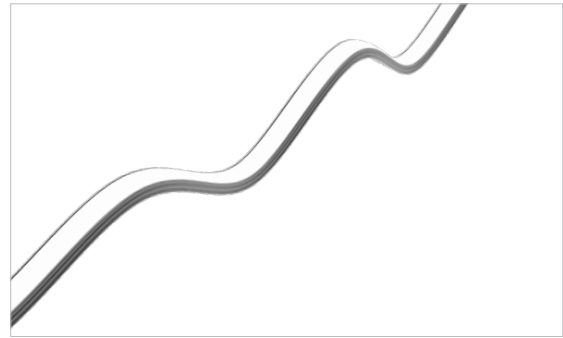

BENDABLE PROFILE

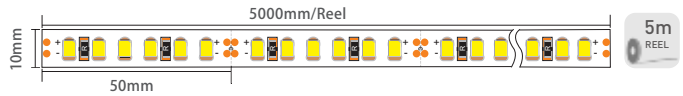
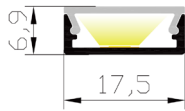

COVER	END CAP	CLIP	
Trans:1707K2 Opal:1707K3 Diffuser:1707K4	Hole:1707K8 W/O hole: 1707K9	170702	LP1707019

NO.BM001

Manual Bend machine

1. Large range multi-size adjustable (Products bend size width 10mm to 49mm;high 1mm to 15mm;length unlimited)
2. Easy to handle and convenient to carry
- 3.Any arc, round, "S" shape, wave shape can be bendable
4. Omnidirectional personalized customization LED profile
5. Manual operation without power supply

LR1105



Silver
 Black
 White (RAL9016)



Can be bent
DIY shape

Material:	AL6063-T5
Surface:	Anodized/ Painting
PC cover:	Diffuser /Transparent /Opal
Power:	7.2W/m
Input voltage:	24VDC
Lamp beads:	120LEDs/m (2835)
Lighting source width:	6 mm
Available lengths:	0.5-3m
Application:	Commercial lighting / Indoor lighting Artistic design/ Creative design

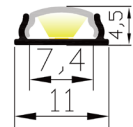
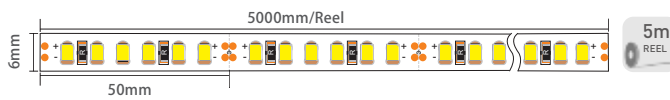

COVER **END CAP** **CLIP** **CONNECTOR**



Trans: 11052
Opal: 11053
Diffuser: 11054



Hole: 11058
W/O hole: 11059



11050



LR1105017

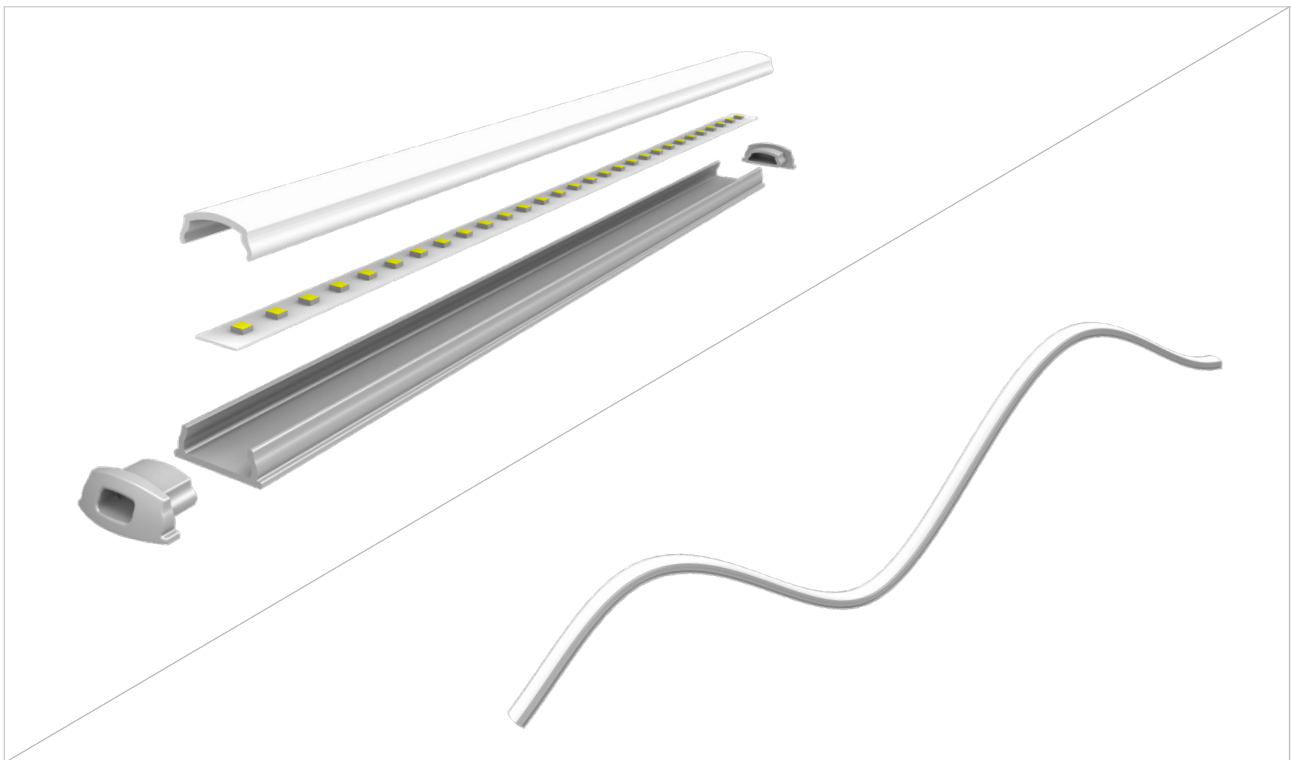

LR1806



- Silver
- Black
- White (RAL9016)

Material:	AL6063-T5
Surface:	Anodized/ Painting
PC cover:	Diffuser /Transparent /Opal
Power:	10W/m
Input voltage:	24VDC
Lamp beads:	120LEDs/m (2835)
Lighting source width:	10 mm
Available lengths:	0.5-3m
Application:	Commercial lighting / Indoor lighting Artistic design/ Creative design



BENDABLE PROFILE

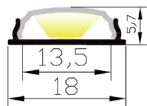

COVER



Trans: 18062
Opal: 18063
Diffuser: 18064

END CAP



Hole: 18068
W/O hole: 18069

CLIP



18060

CONNECTOR



LR1806017

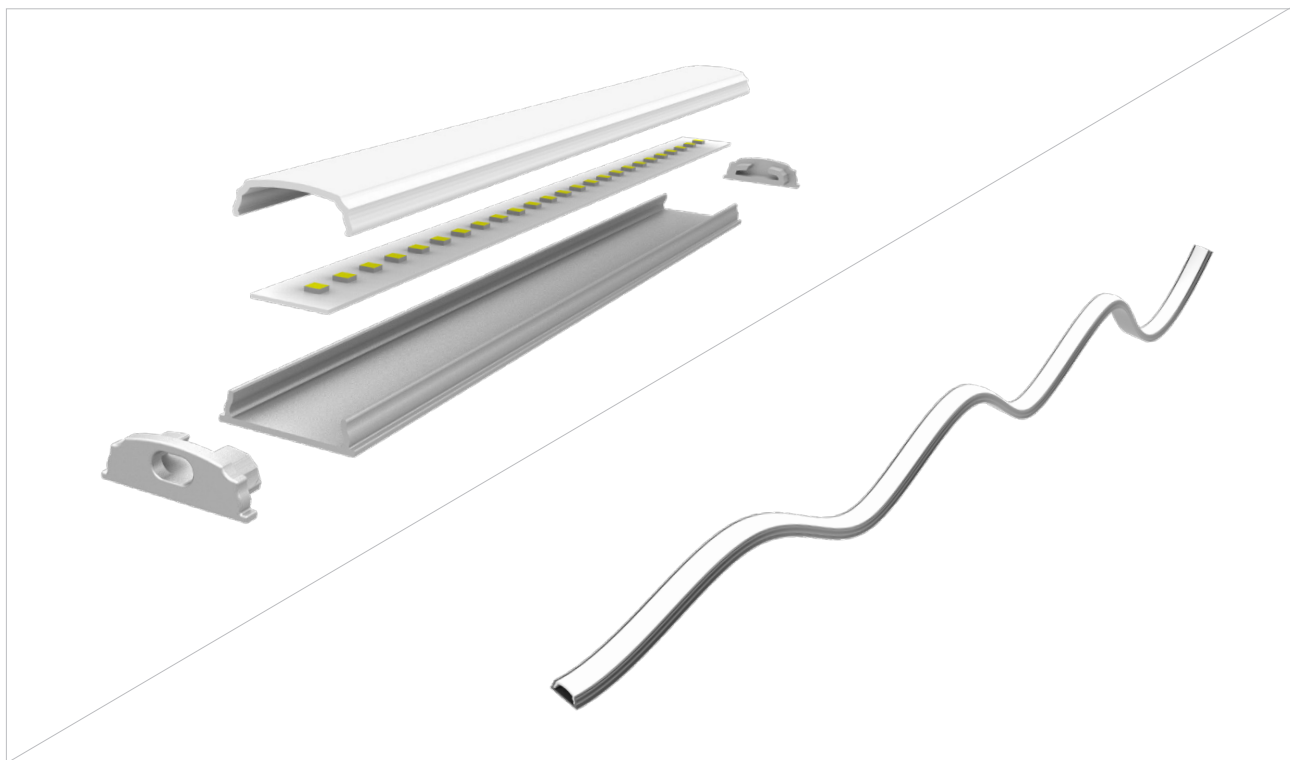

LR3916



Silver
 Black
 White (RAL9016)



Material:	AL6063-T5
Surface:	Anodized/ Painting
PC cover:	Diffuser /Transparent /Opal
Power:	28.8W/m
Input voltage:	24VDC
Lamp beads:	240LEDs/m (2835)
Lighting source width:	10 mm x2pcs
Available lengths:	0.5-3m
Application:	Commercial lighting / Indoor lighting Artistic design/ Creative design

BENDABLE PROFILE

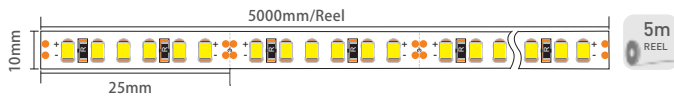
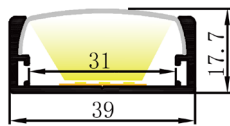

COVER

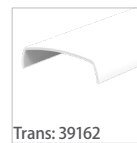

Trans: 39162
 Opal: 39163
 Diffuser: 39164

END CAP



Hole: 39168
 W/O hole: 39169

CLIP



39160

CONNECTOR



LR3916017

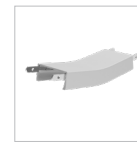

LR3916018



LR3916019



BENTABLE PROFILE

BENDABLE PROFILE

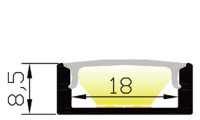

LP2208-R

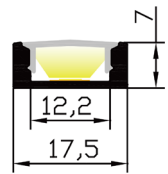

LP1707B-R

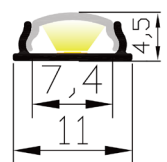

LR1105

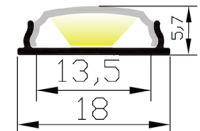

LR1806

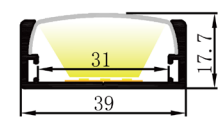

LR3916

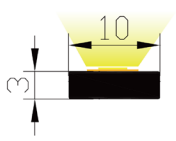

LP1003-R

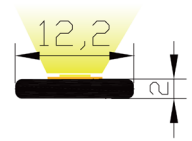

LP1202-R

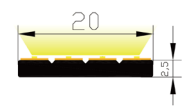

LP2003-R

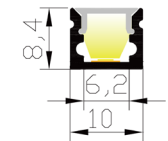

LP0810-R

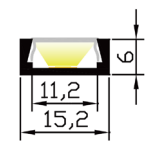

LP1506D-R

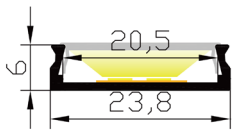

LP2406-R

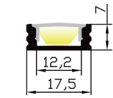

LP1707-R

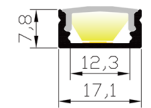

LP1707D-R

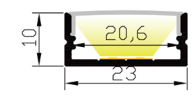

LP2310-R

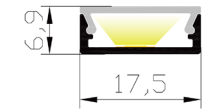

LP1707K-R

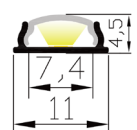

LR1105

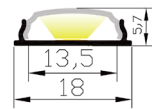

LR1806

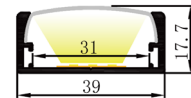

LR3916

INSTALLATION

BENDABLE PROFILE

For LR1105 / LR1806

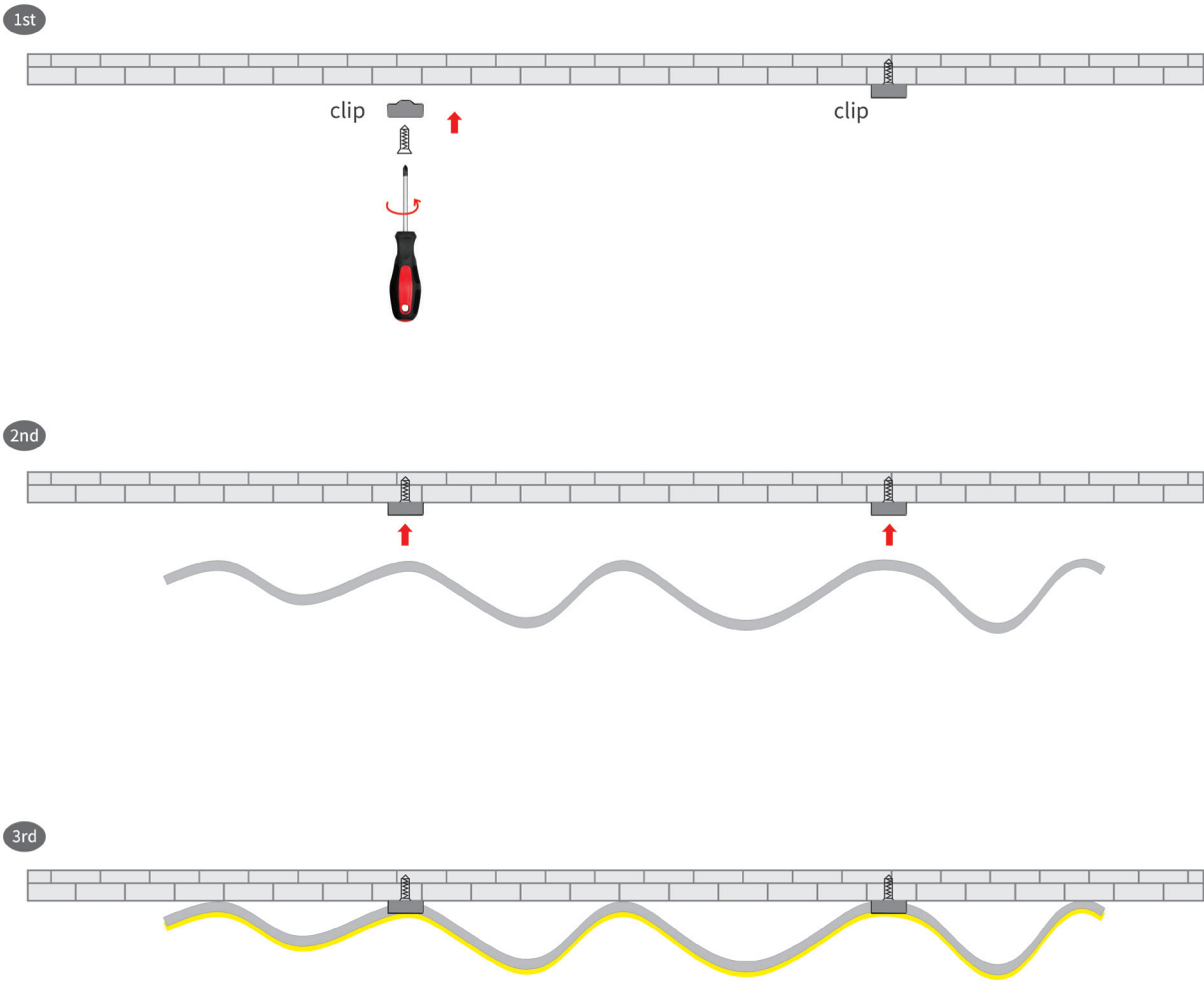

For LR3916

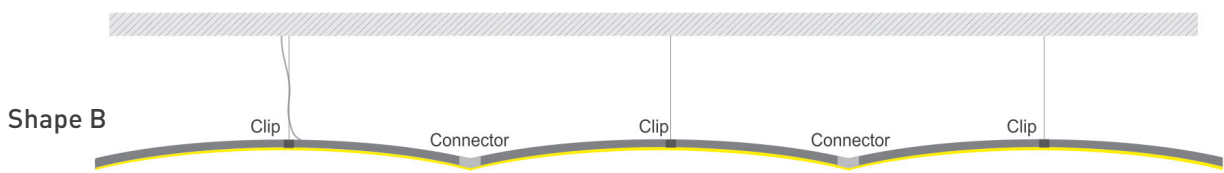
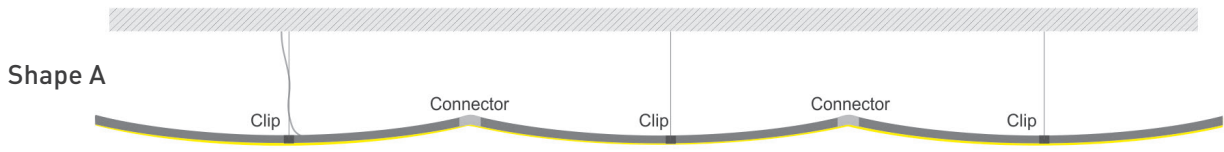
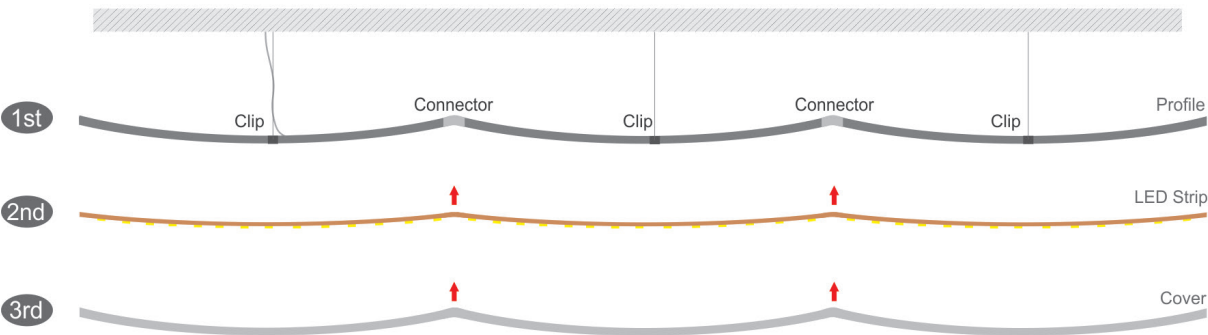

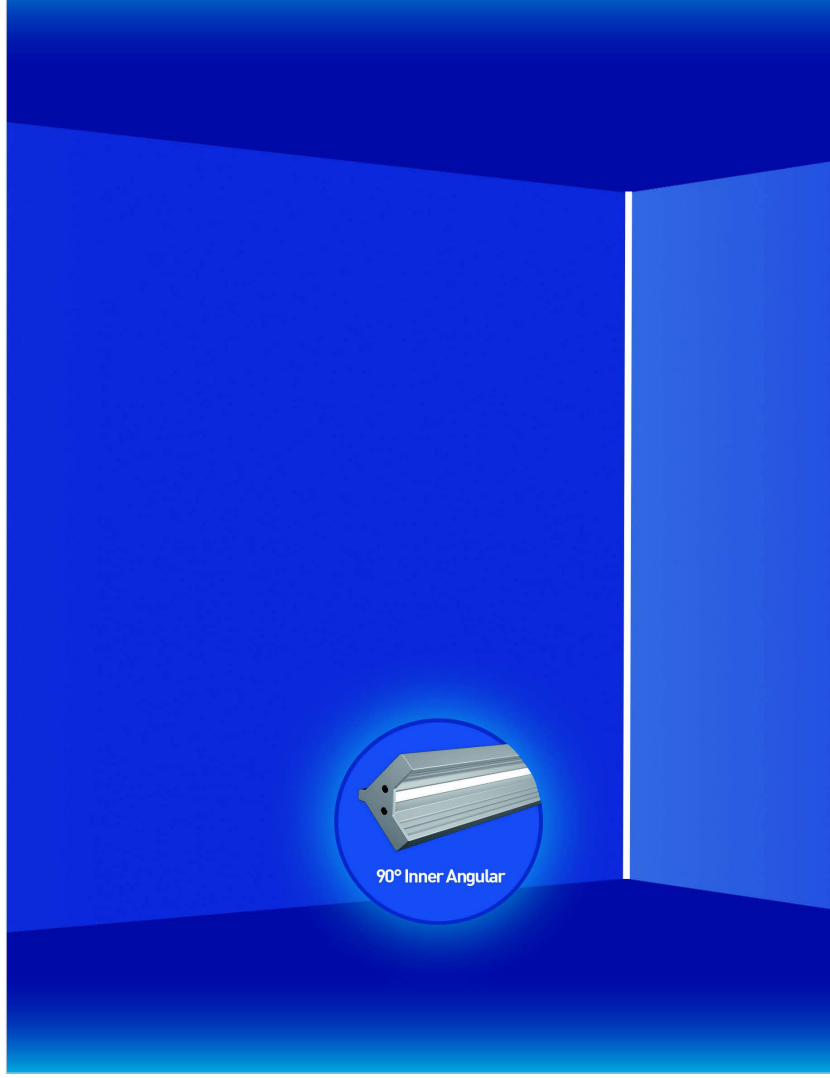

Decorative LED Profile

Designing different illumination products according to different surroundings , (Smallpox, wall under corner, inside corner, outside corner, etc) it perfectly explains the combination and the artistic conception of light and space .







Design Of Connectors With Different Angles

Designed to create different lighting environments

The function as connecting

Convenient of operation

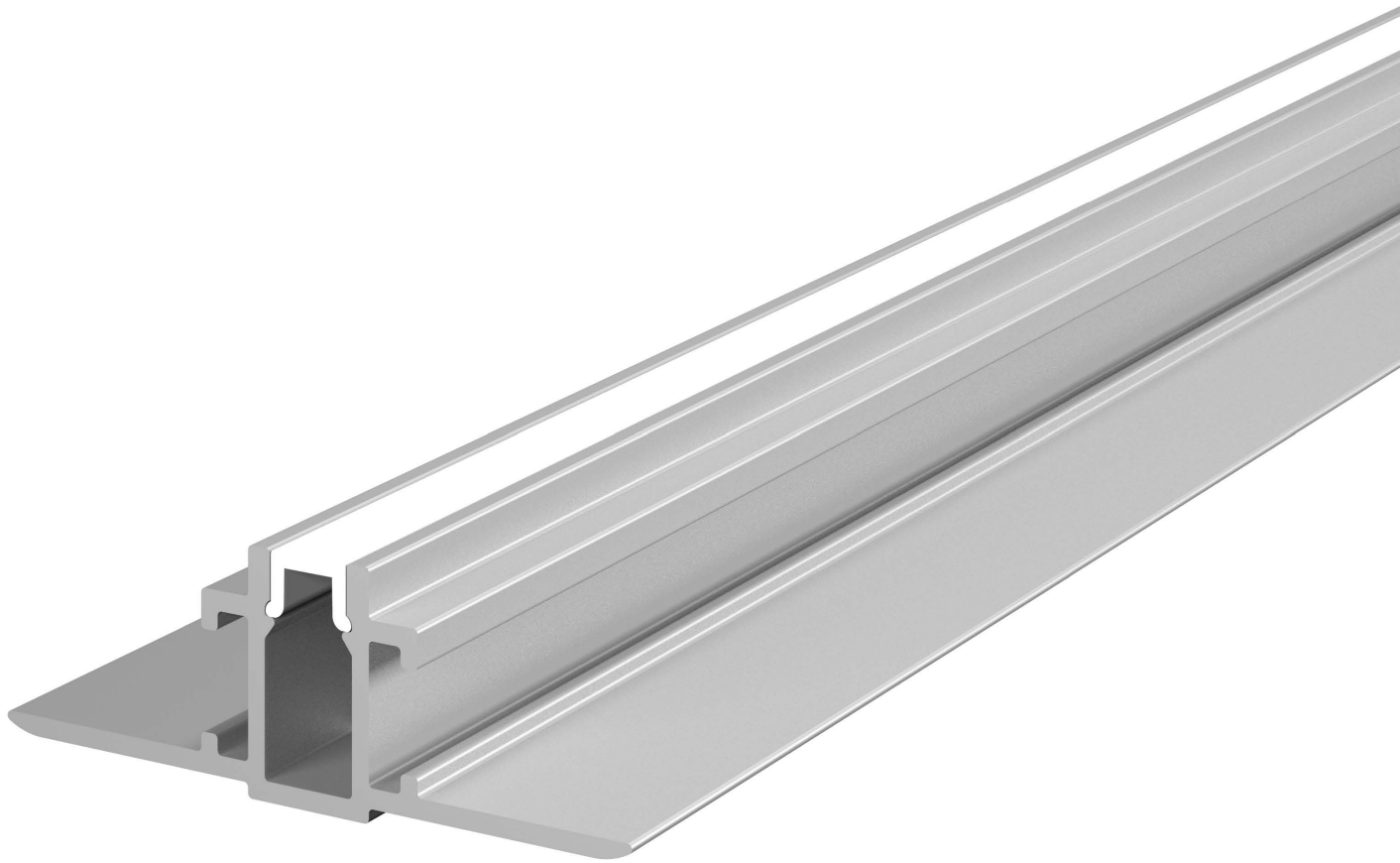

180° connector

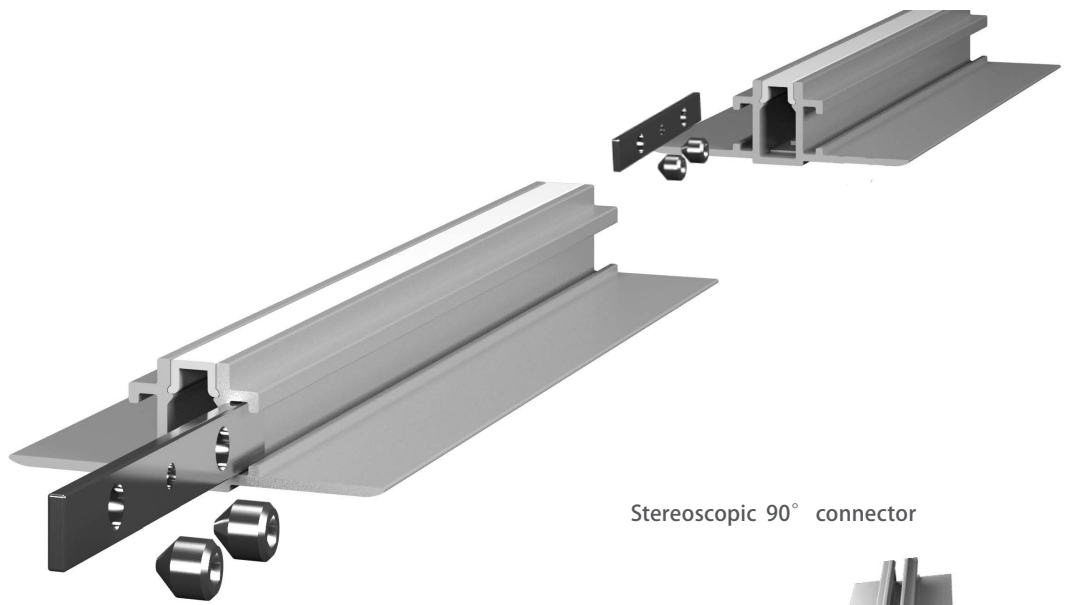

Stereoscopic 90° connector

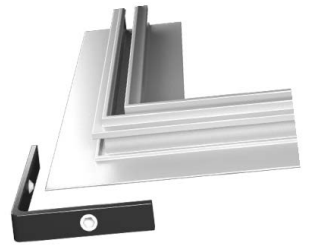

90° connector

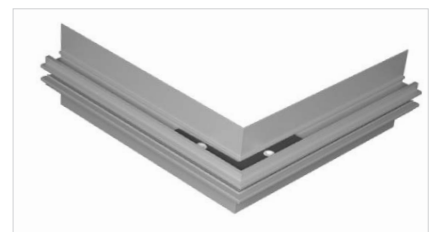
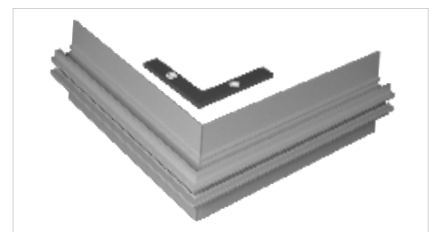

LD10220

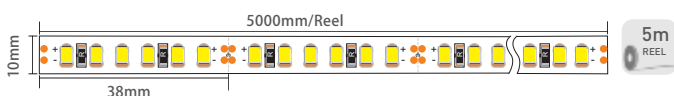

COVER



Trans:10202
Opal: 10203
Diffuser:10204

COVER



Trans:17072
Opal: 17073
Diffuser:17074

END CAP



W/O hole: 102209

CLIP



25205

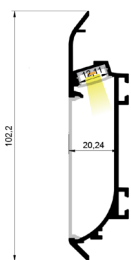

Silver



Black



White
(RAL9016)

Material:	AL6063-T5
Surface:	Anodized/ Painting
PC cover:	Diffuser /Transparent /Opal
Power:	14.4W/m
Input voltage:	24VDC
Lamp beads:	156LEDs/m (2835)
Lighting source width:	10 mm
Available lengths:	0.5-3m
Application:	Commercial lighting / Indoor lighting



LD10220C

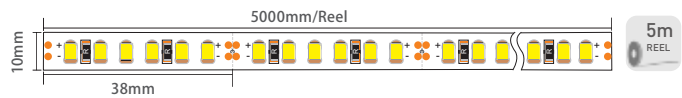
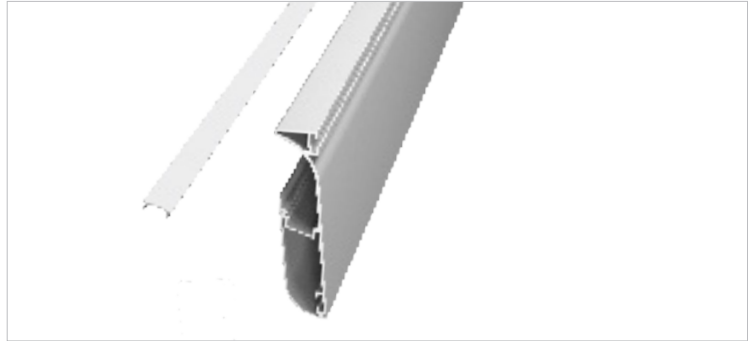

DECORATIVE PROFILE

COVER

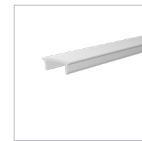

Trans:17072
Opal: 17073
Diffuser:17074

END CAP



W/O hole: 10220B9

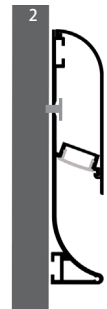
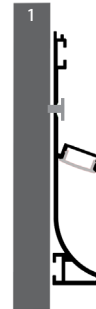
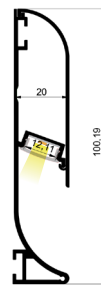

Material:	AL6063-T5
Surface:	Anodized/ Painting
PC cover:	Diffuser /Transparent /Opal
Power:	14.4W/m
Input voltage:	24VDC
Lamp beads:	156LEDs/m (2835)
Lighting source width:	10 mm
Available lengths:	0.5-3m
Application:	Commercial lighting / Indoor lighting

LD3010



Silver
 Black
 White (RAL9016)



Material:	AL6063-T5
Surface:	Anodized/ Painting
PC cover:	Diffuser /Transparent /Opal
Power:	14.4W/m
Input voltage:	24VDC
Lamp beads:	156LEDs/m (3014)
Lighting source width:	4 mm
Available lengths:	0.5-3m
Application:	Commercial lighting / Indoor lighting

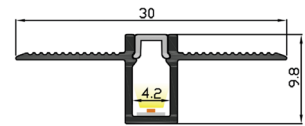
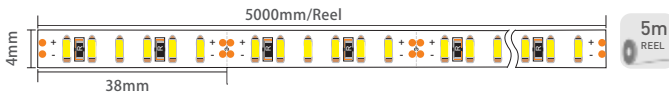

COVER

Trans:05072
 Opal: 05073
 Diffuser:05074



END CAP

Hole:30108
 W/O hole: 30109

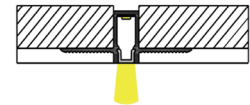

DECORATIVE PROFILE

LD3010B



Silver	Black	White <small>(ral9016)</small>
Material:	AL6063-T5	
Surface:	Anodized/ Painting	
PC cover:	Diffuser /Transparent /Opal	
Power:	14.4W/m	
Input voltage:	24VDC	
Lamp beads:	156LEDs/m (3014)	
Lighting source width:	4 mm	
Available lengths:	0.5-3m	
Application:	Commercial lighting / Indoor lighting	

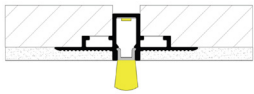
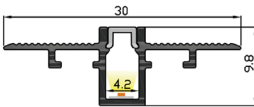
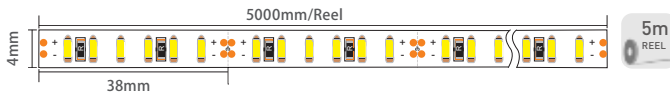

COVER

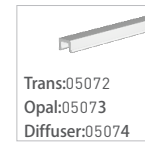

END CAP



OTHERS

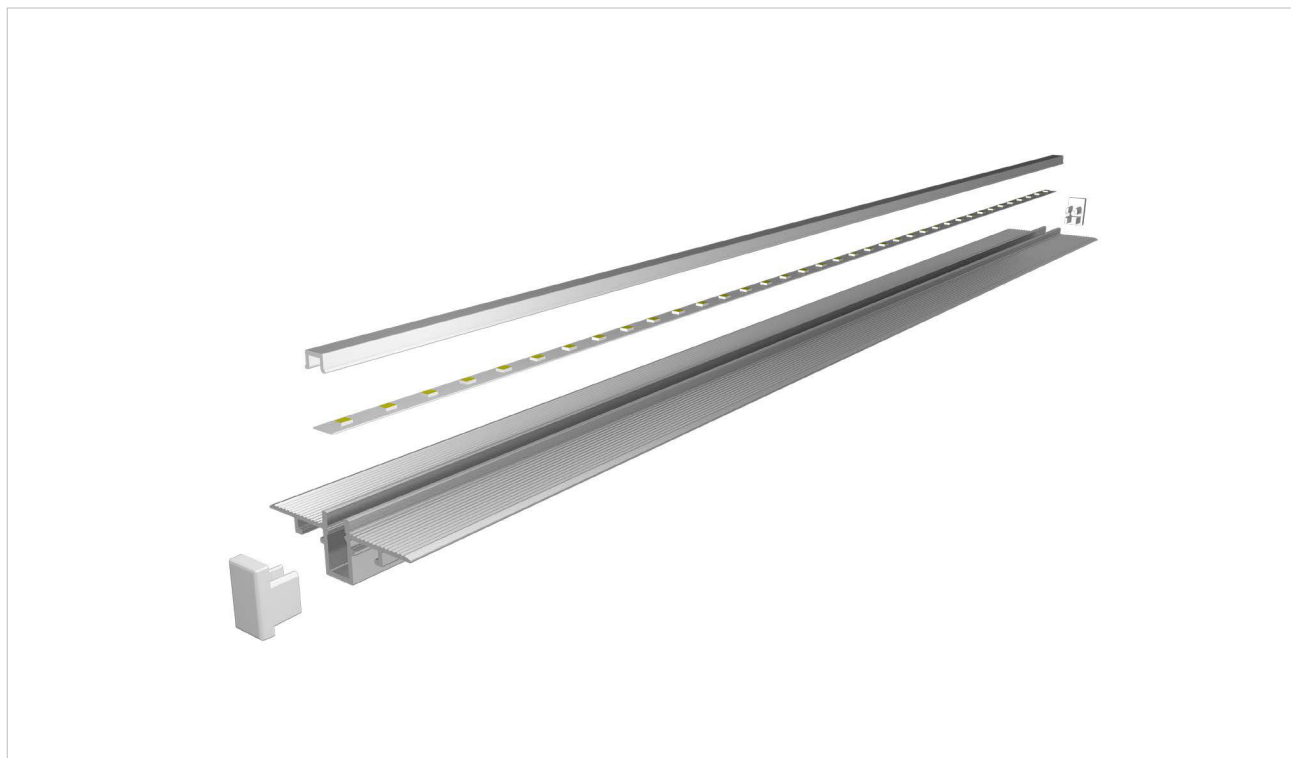

DECORATIVE PROFILE

LD3010C

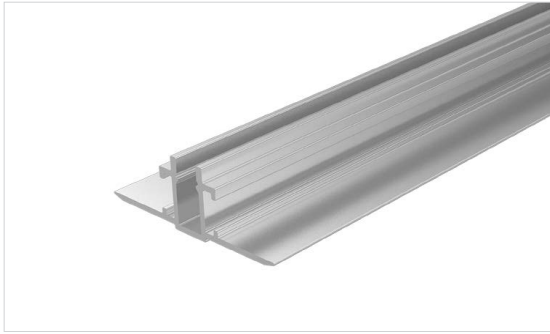

Material:	AL6063-T5
Surface:	Anodized/ Painting
PC cover:	Diffuser /Transparent /Opal
Power:	14.4W/m
Input voltage:	24VDC
Lamp beads:	156LEDs/m (3014)
Lighting source width:	4 mm
Available lengths:	0.5-3m
Application:	Commercial lighting / Indoor lighting

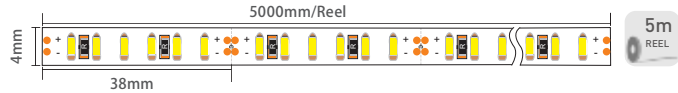

COVER

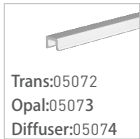

END CAP

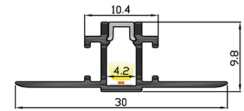

OTHERS

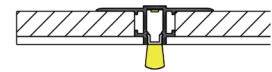

LD4010



Material:	AL6063-T5
Surface:	Anodized/ Painting
PC cover:	Diffuser /Transparent /Opal
Power:	14.4W/m
Input voltage:	24VDC
Lamp beads:	156LEDs/m (3014)
Lighting source width:	4 mm
Available lengths:	0.5-3m
Application:	Commercial lighting / Indoor lighting

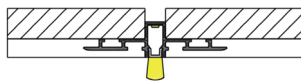
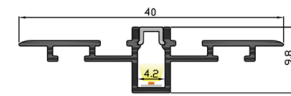
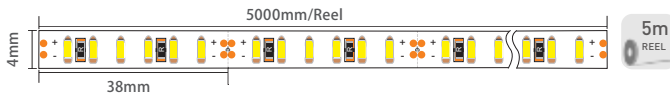

COVER

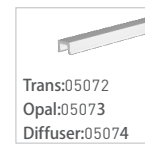

END CAP



OTHERS

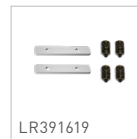

DECORATIVE PROFILE

LD5015



Silver
 Black
 White
(ral9016)

Material:	AL6063-T5
Surface:	Anodized/ Painting
PC cover:	Diffuser /Transparent /Opal
Power:	14.4W/m
Input current:	24VDC
Lamp beads:	156LEDs/m (2835)
Lighting source width:	10 mm
Available lengths:	0.5-3m
Application:	Commercial lighting / Indoor lighting



DECORATIVE PROFILE



COVER

Trans:17072
Opal:17073
Diffuser:17074

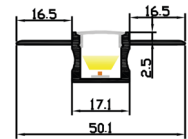

END CAP

Hole:17158
W/O hole:17159



LD5015B



Silver
 Black
 White
(ral9016)

Material:	AL6063-T5
Surface:	Anodized/ Painting
PC cover:	Diffuser /Transparent /Opal
Power:	14.4W/m
Input current:	24VDC
Lamp beads:	156LEDs/m (2835)
Lighting source width:	10 mm
Available lengths:	0.5-3m
Application:	Commercial lighting / Indoor lighting

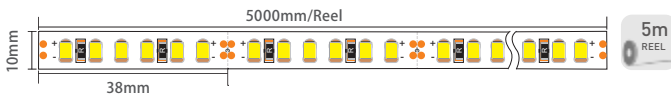
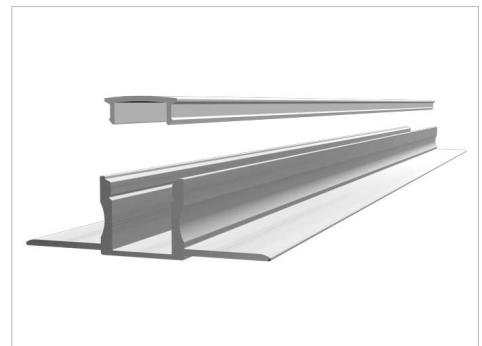

COVER

Trans:17072
Opal:17073
Diffuser:17074



END CAP

Hole:17158
W/O hole:17159



LD5015C



- Silver
- Black
- White (ral9016)

Material:	AL6063-T5
Surface:	Anodized/ Painting
PC cover:	Diffuser /Transparent /Opal
Power:	14.4W/m
Input current:	24VDC
Lamp beads:	156LEDs/m (2835)
Lighting source width:	10 mm
Available lengths:	0.5-3m
Application:	Commercial lighting / Indoor lighting

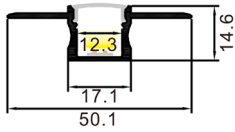
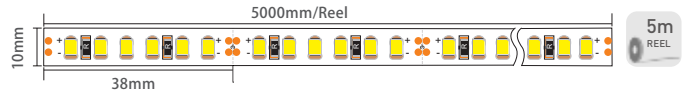
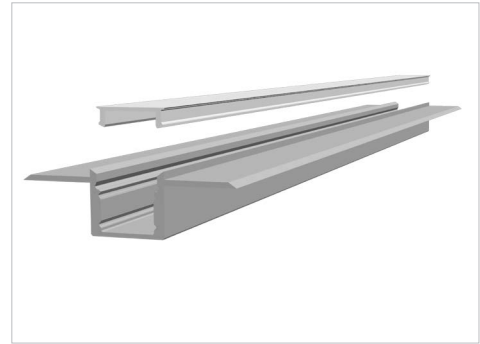

COVER

- Trans:1707D2
- Opal:1707D3
- Diffuser:1707D4



END CAP

- Hole:1715B8
- W/O hole:1715B9



DECORATIVE PROFILE

LD5015D



- Silver
- Black
- White (ral9016)

Material:	AL6063-T5
Surface:	Anodized/ Painting
PC cover:	Diffuser /Transparent /Opal
Power:	14.4W/m
Input current:	24VDC
Lamp beads:	156LEDs/m (2835)
Lighting source width:	10 mm
Available lengths:	0.5-3m
Application:	Commercial lighting / Indoor lighting

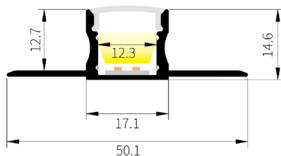
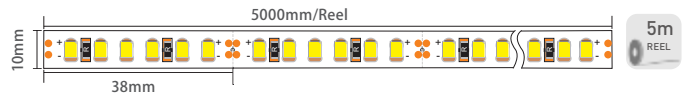
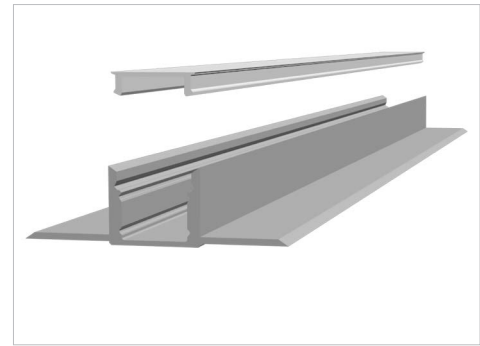

COVER

- Trans:1707D2
- Opal:1707D3
- Diffuser:1707D4



END CAP

- Hole:1715B8
- W/O hole:1715B9



LD5218



Silver
 Black
 White (RAL9016)

Material:	AL6063-T5
Surface:	Anodized/ Painting
PC cover:	Diffuser /Transparent /Opal
Power:	14.4W/m
Input voltage:	24VDC
Lamp beads:	120LEDs/m (3014)
Lighting source width:	4 mm
Available lengths:	0.5-3m
Application:	Commercial lighting / Indoor lighting



COVER

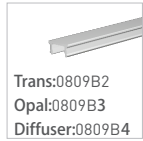

END CAP

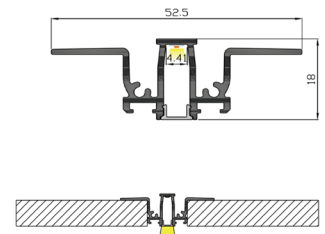
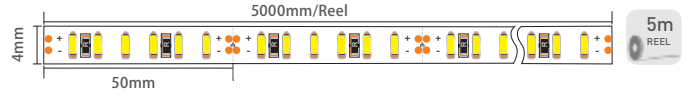

OTHERS



LD4545



Silver
 Black
 White (RAL9016)

Material:	AL6063-T5
Surface:	Anodized/ Painting
PC cover:	Diffuser /Transparent /Opal
Power:	14.4W/m
Input voltage:	24VDC
Lamp beads:	120LEDs/m (3014)
Lighting source width:	4 mm
Available lengths:	0.5-3m
Application:	Commercial lighting / Indoor lighting



COVER

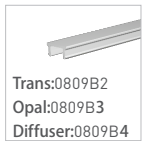

END CAP

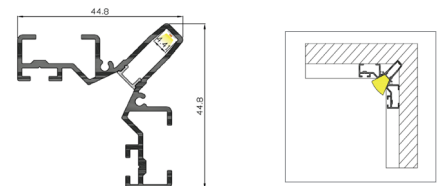
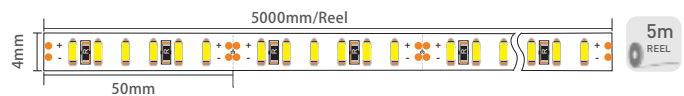

OTHERS



LD4747



Silver
 Black
 White (RAL9016)

Material:	AL6063-T5
Surface:	Anodized/ Painting
PC cover:	Diffuser /Transparent /Opal
Power:	14.4W/m
Input voltage:	24VDC
Lamp beads:	120LEDs/m (3014)
Lighting source width:	4 mm
Available lengths:	0.5-3m
Application:	Commercial lighting / Indoor lighting

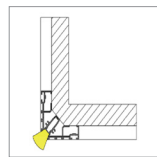
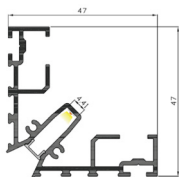
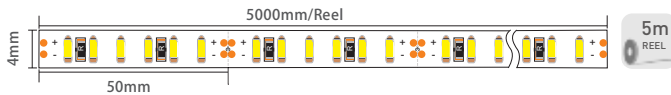

COVER

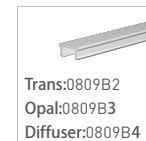

END CAP



OTHERS



LD3535



Silver
 Black
 White (RAL9016)

Material:	AL6063-T5
Surface:	Anodized/ Painting
PC cover:	Diffuser /Transparent /Opal
Power:	14.4W/m
Input voltage:	24VDC
Lamp beads:	156LEDs/m (3014)
Lighting source width:	4 mm
Available lengths:	0.5-3m
Application:	Commercial lighting / Indoor lighting

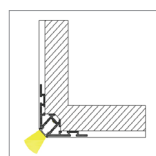
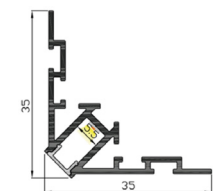
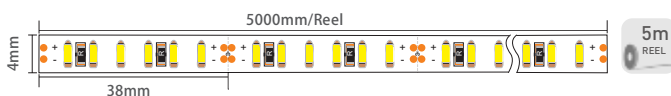

COVER

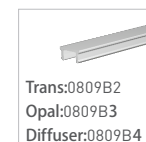

END CAP

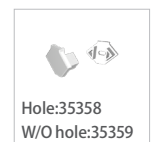

OTHERS

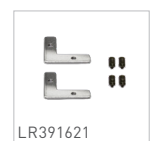
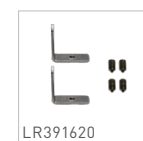
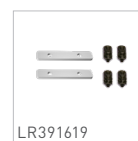

LD3535B



Silver
 Black
 White (ral9016)

Material:	AL6063-T5
Surface:	Anodized/ Painting
PC cover:	Diffuser /Transparent /Opal
Power:	14.4W/m
Input voltage:	24VDC
Lamp beads:	156LEDs/m (3014)
Lighting source width:	4 mm
Available lengths:	0.5-3m
Application:	Commercial lighting / Indoor lighting



COVER

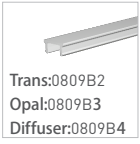

END CAP

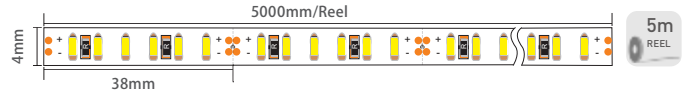

OTHERS

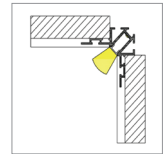
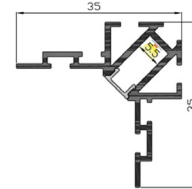

LD1145



Silver
 Black
 White (ral9016)

Material:	AL6063-T5
Surface:	Anodized/ Painting
PC cover:	Diffuser /Transparent /Opal
Power:	14.4W/m
Input voltage:	24VDC
Lamp beads:	156LEDs/m (3014)
Lighting source width:	4 mm
Available lengths:	0.5-3m
Application:	Commercial lighting / Indoor lighting

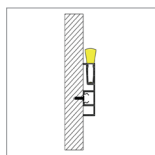
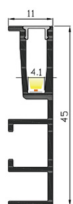
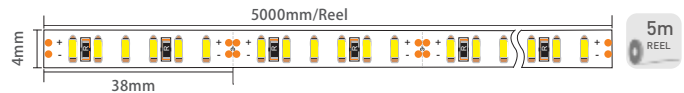
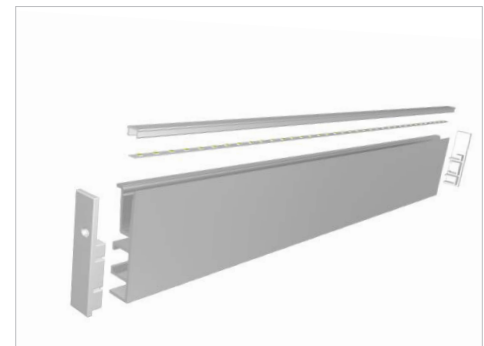

COVER

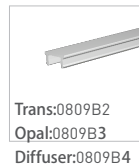

END CAP



OTHERS



LD1170



Silver
 Black
 White (RAL9016)

Material:	AL6063-T5
Surface:	Anodized/ Painting
PC cover:	Diffuser /Transparent /Opal
Power:	28.8W/m
Input voltage:	12VDC
Lamp beads:	312LEDs/m (3014)
Lighting source width:	4 mm x2pcs
Available lengths:	0.5-3m
Application:	Commercial lighting / Indoor lighting

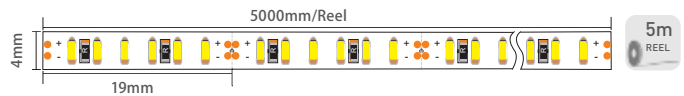
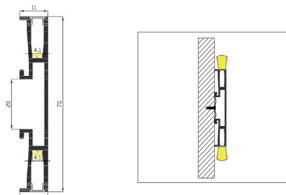

COVER	Trans:0809B2 Opal:0809B3 Diffuser:0809B4	
END CAP	Hole:11708 W/O hole:11709	

DECORATIVE PROFILE

LD1418



Silver
 Black
 White (RAL9016)

Material:	AL6063-T5
Surface:	Anodized/ Painting
PC cover:	Diffuser /Transparent /Opal
Power:	14.4W/m
Input voltage:	24VDC
Lamp beads:	120LEDs/m (3014)
Lighting source width:	4 mm
Available lengths:	0.5-3m
Application:	Commercial lighting / Indoor lighting

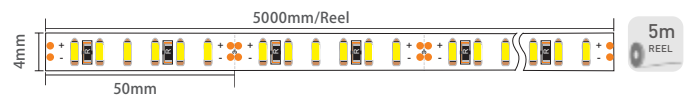
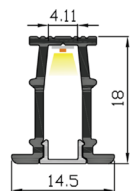

COVER	Trans:0809B2 Opal:0809B3 Diffuser:0809B4	
END CAP	Hole:14188 W/O hole:14189	

LD13519

CE IP20

Silver
 Black
 White (RAL9016)

Material:	AL6063-T5
Surface:	Anodized/ Painting
PC cover:	Diffuser /Transparent /Opal
Power:	14.4W/m
Input voltage:	24VDC
Lamp beads:	120LEDs/m (2835)
Lighting source width:	10 mm
Available lengths:	0.5-3m
Application:	Commercial lighting / Indoor lighting

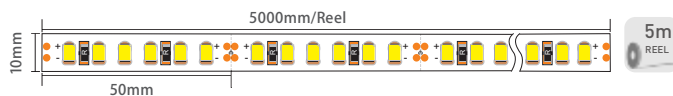
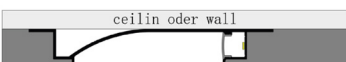
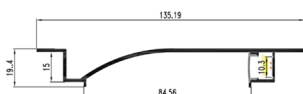

COVER

Trans:17072
 Opal:17073
 Diffuser:17074



LD6316

CE IP20

Silver
 Black
 White (RAL9016)

Material:	AL6063-T5
Surface:	Anodized/ Painting
PC cover:	Diffuser /Transparent /Opal
Power:	14.4W/m
Input voltage:	24VDC
Lamp beads:	120LEDs/m (2835)
Lighting source width:	10 mm
Available lengths:	0.5-3m
Application:	Commercial lighting / Indoor lighting

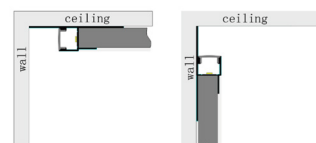
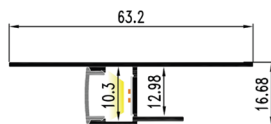
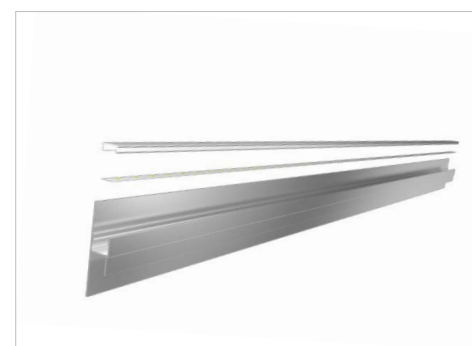

COVER

Trans:17072
 Opal:17073
 Diffuser:17074



LD6316A

CE IP20

Silver
 Black
 White (RAL9016)

Material:	AL6063-T5
Surface:	Anodized/ Painting
Power:	14.4W/m
Input voltage:	24VDC
Lamp beads:	120LEDs/m (2835)
Lighting source width:	10 mm
Available lengths:	0.5-3m
Application:	Commercial lighting / Indoor lighting

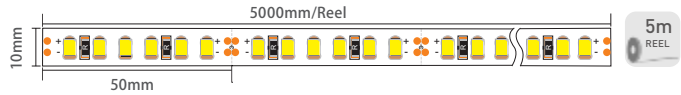
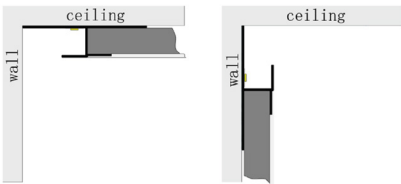
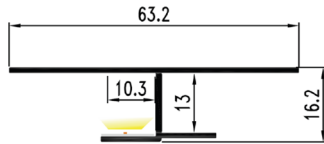
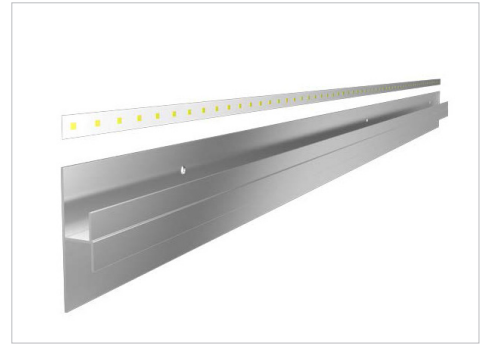

LD6319

CE IP20

Silver
 Black
 White (RAL9016)

Material:	AL6063-T5
Surface:	Anodized/ Painting
PC cover:	Diffuser/Transparent/Opal
Power:	14.4W/m
Input voltage:	24VDC
Lamp beads:	120LEDs/m (2835)
Lighting source width:	10 mm
Available lengths:	0.5-3m
Application:	Commercial lighting / Indoor lighting

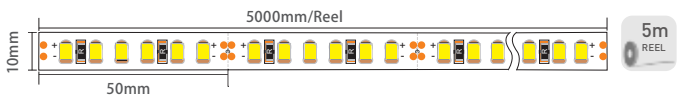
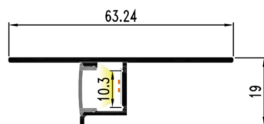

COVER

Trans:17072
 Opal:17073
 Diffuser:17074



LD5452



Silver
 Black
 White (RAL9016)

Material:	AL6063-T5
Surface:	Anodized/ Painting
PC cover:	Diffuser /Transparent /Opal
Power:	14.4W/m
Input voltage:	24VDC
Lamp beads:	120LEDs/m (2835)
Lighting source width:	10 mm
Available lengths:	0.5-3m
Application:	Commercial lighting / Indoor lighting

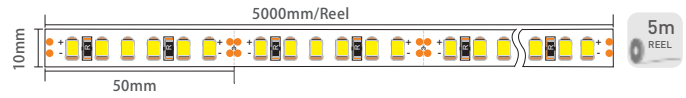
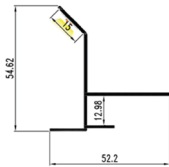
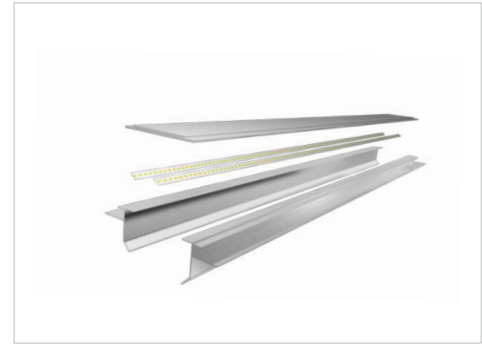

COVER

Trans:54522
 Opal:54523
 Diffuser:54524



LD4716



Silver
 Black
 White (RAL9016)

Material:	AL6063-T5
Surface:	Anodized/ Painting
PC cover:	Diffuser /Transparent /Opal
Power:	14.4W/m
Input voltage:	24VDC
Lamp beads:	156LEDs/m (2835)
Lighting source width:	10 mm
Available lengths:	0.5-3m
Application:	Commercial lighting / Indoor lighting

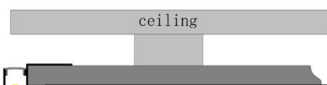
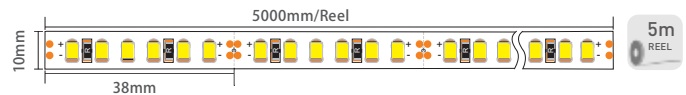
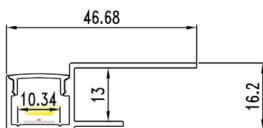
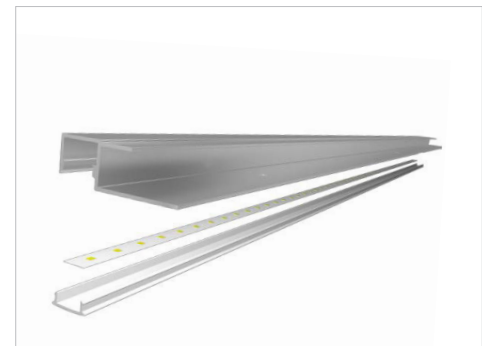

COVER

Trans:17072
 Opal:17073
 Diffuser:17074



END CAP

Hole:47168
 W/O hole:47169



LD1146



Material:	AL6063-T5
Surface:	Anodized/ Painting
PC cover:	Diffuser /Transparent /Opal
Power:	28.8W/m
Input voltage:	24VDC
Lamp beads:	240LEDs/m (2835)
Lighting source width:	10 mm x2pcs
Available lengths:	0.5-3m
Application:	Commercial lighting / Indoor lighting Artistic design/ Creative design

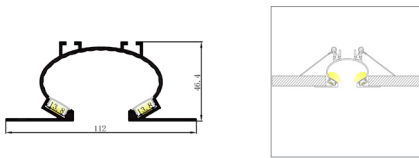
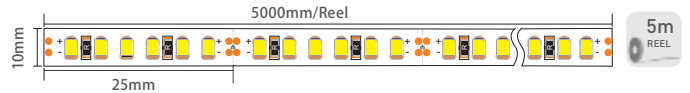
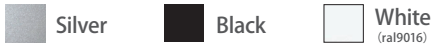
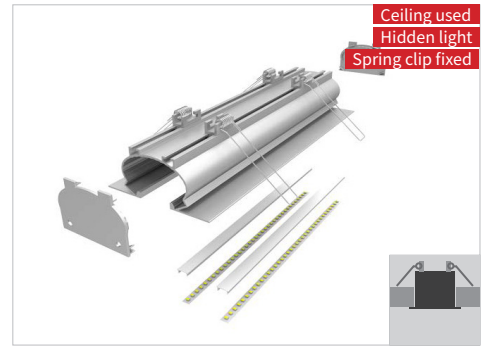

COVER

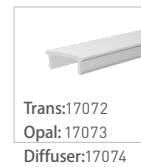

END CAP



OTHERS



LD1970



Material:	AL6063-T5
Surface:	Anodized/ Painting
Power:	14.4W/m
Input voltage:	24VDC
Lamp beads:	120LEDs/m (2835)
Lighting source width:	10 mm
Available lengths:	0.5-3m
Application:	Commercial lighting / Indoor lighting Artistic design/ Creative design

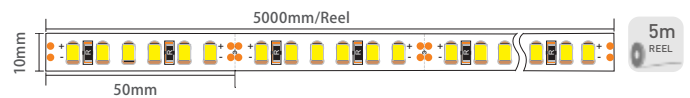
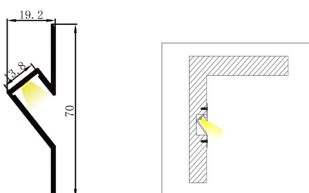
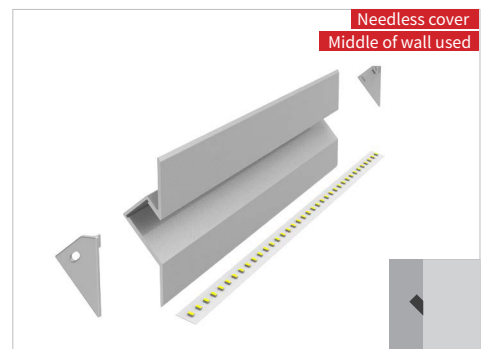

END CAP

Hole: 19708
W/O hole: 19709



LD3611

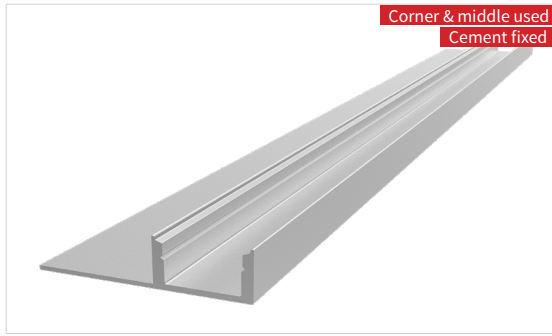

Material:	AL6063-T5
Surface:	Anodized/ Painting
PC cover:	Diffuser /Transparent /Opal
Power:	14.4W/m
Input voltage:	24VDC
Lamp beads:	156LEDs/m (2835)
Lighting source width:	10 mm
Available lengths:	0.5-3m
Application:	Commercial lighting / Indoor lighting Artistic design/ Creative design

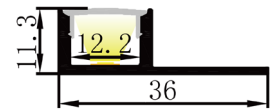
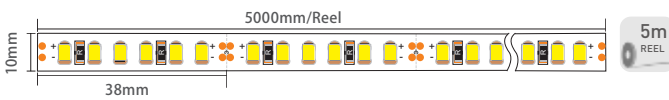

COVER

Trans:17072
Opal:17073
Diffuser:17074



END CAP

Hole:36118
W/O hole: 36119

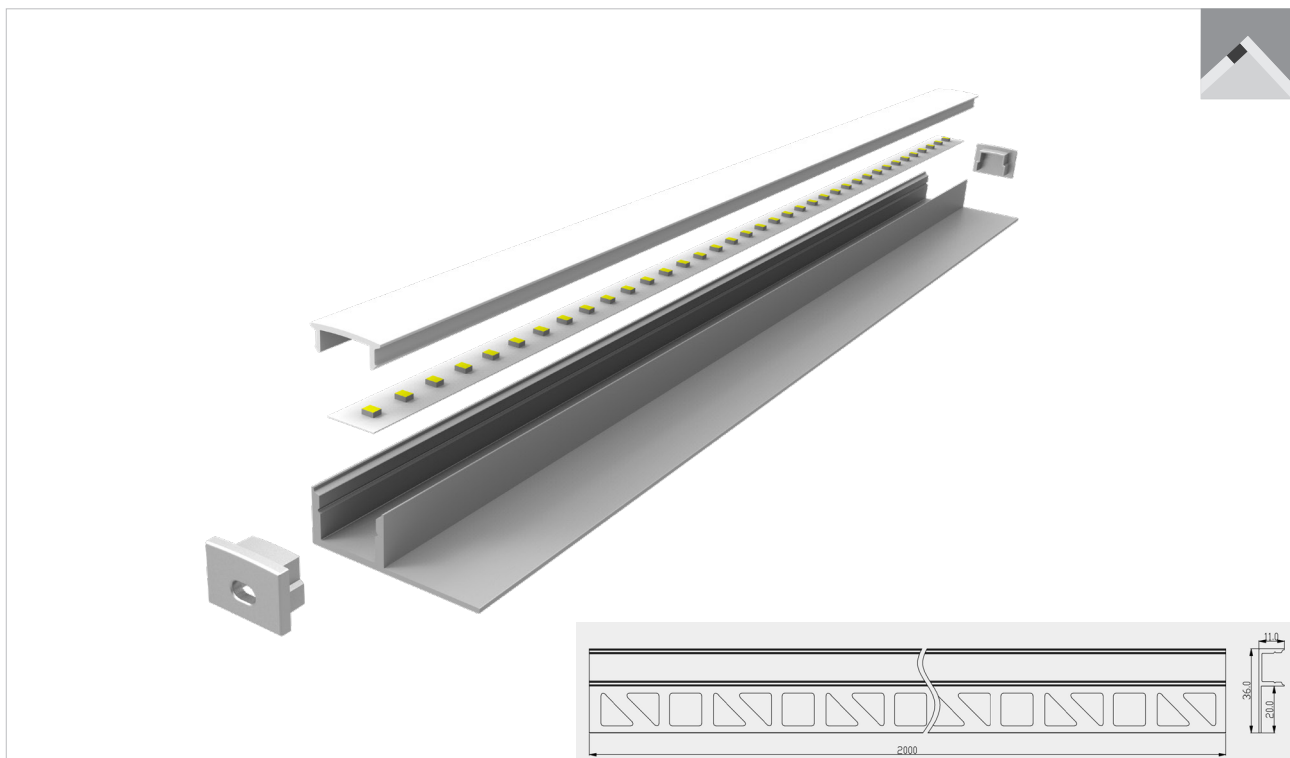
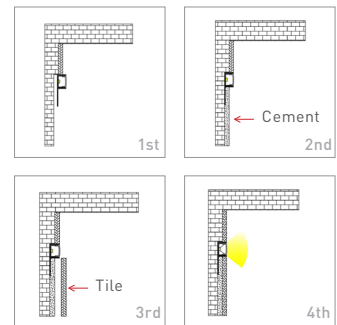

LD3636/LD3636B



Material:	AL6063-T5
Surface:	Anodized/ Painting
PC cover:	Diffuser /Transparent /Opal
Power:	14.4W/m
Input voltage:	24VDC
Lamp beads:	198/156LEDs/m (2835)
Lighting source width:	10 mm
Available lengths:	0.5-3m
Application:	Commercial lighting / Indoor lighting Artistic design/ Creative design



Outside corner used

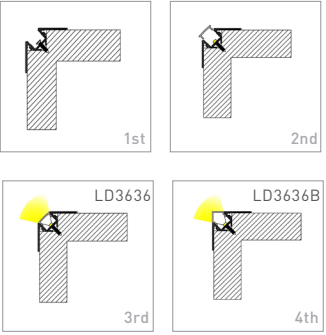
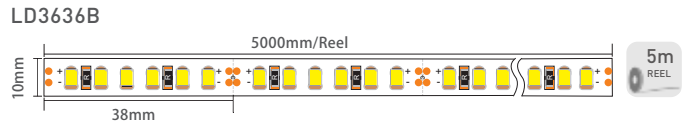
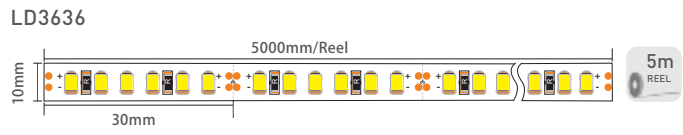
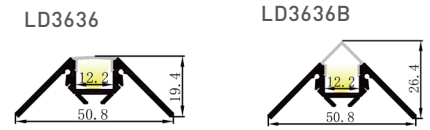

COVER		END CAP	
Trans:17072	Trans:4343B2	Hole:36368	Hole:3636B8
Opal:17073	Opal:4343B3	W/O hole: 36369	W/O hole: 3636B9
Diffuser:17074	Diffuser:4343B4		

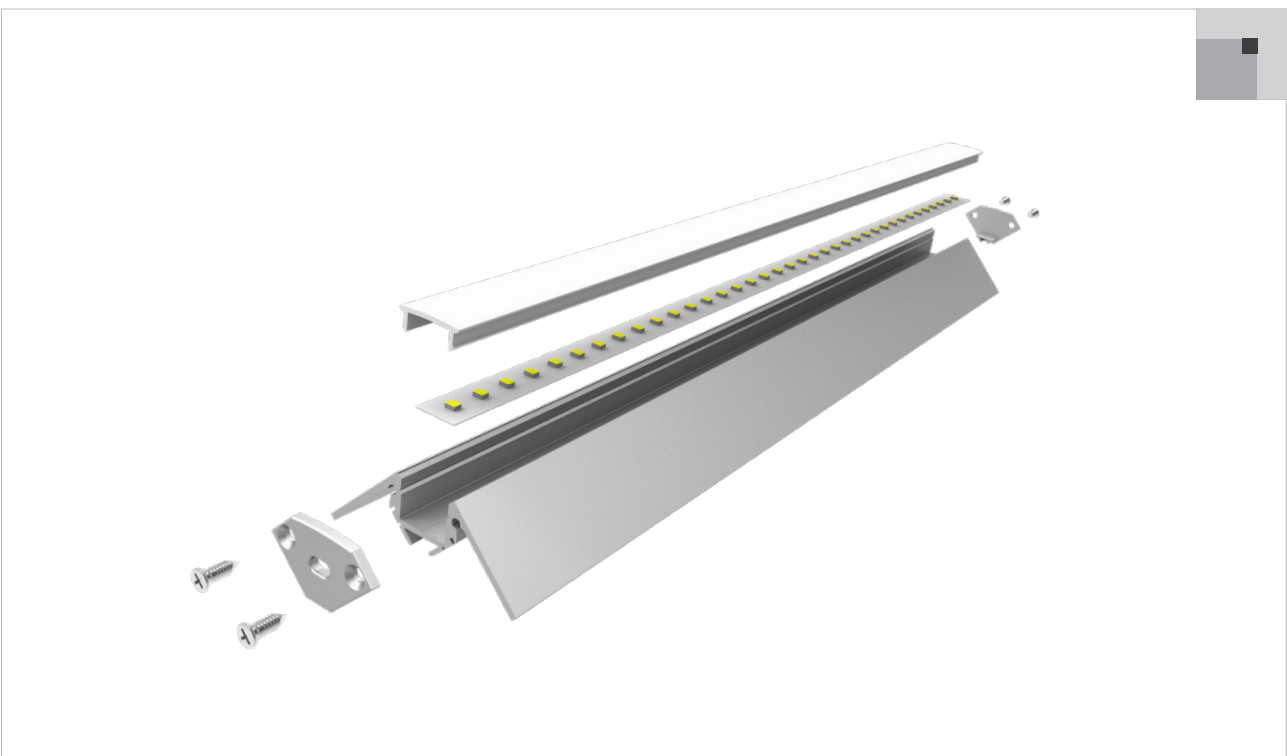

LD4242/LD4242B



Material:	AL6063-T5
Surface:	Anodized/ Painting
PC cover:	Diffuser /Transparent /Opal
Power:	14.4W/m
Input voltage:	24VDC
Lamp beads:	120/156LEDs/m (2835)
Lighting source width:	10 mm
Available lengths:	0.5-3m
Application:	Commercial lighting / Indoor lighting Artistic design/ Creative design



DECORATIVE PROFILE

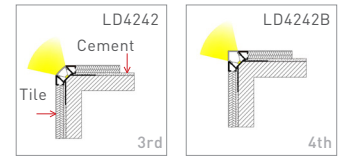
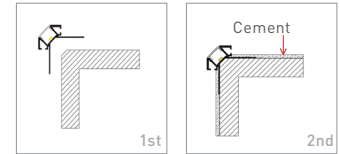
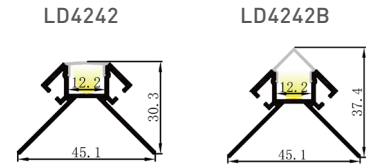
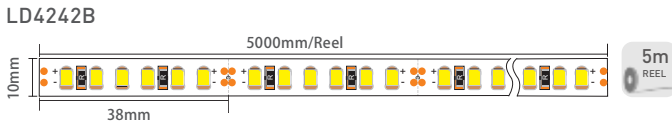
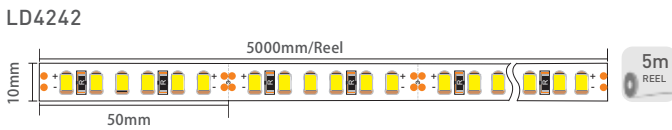

COVER

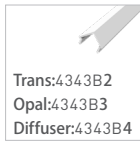
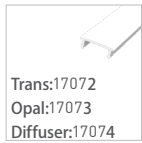

END CAP

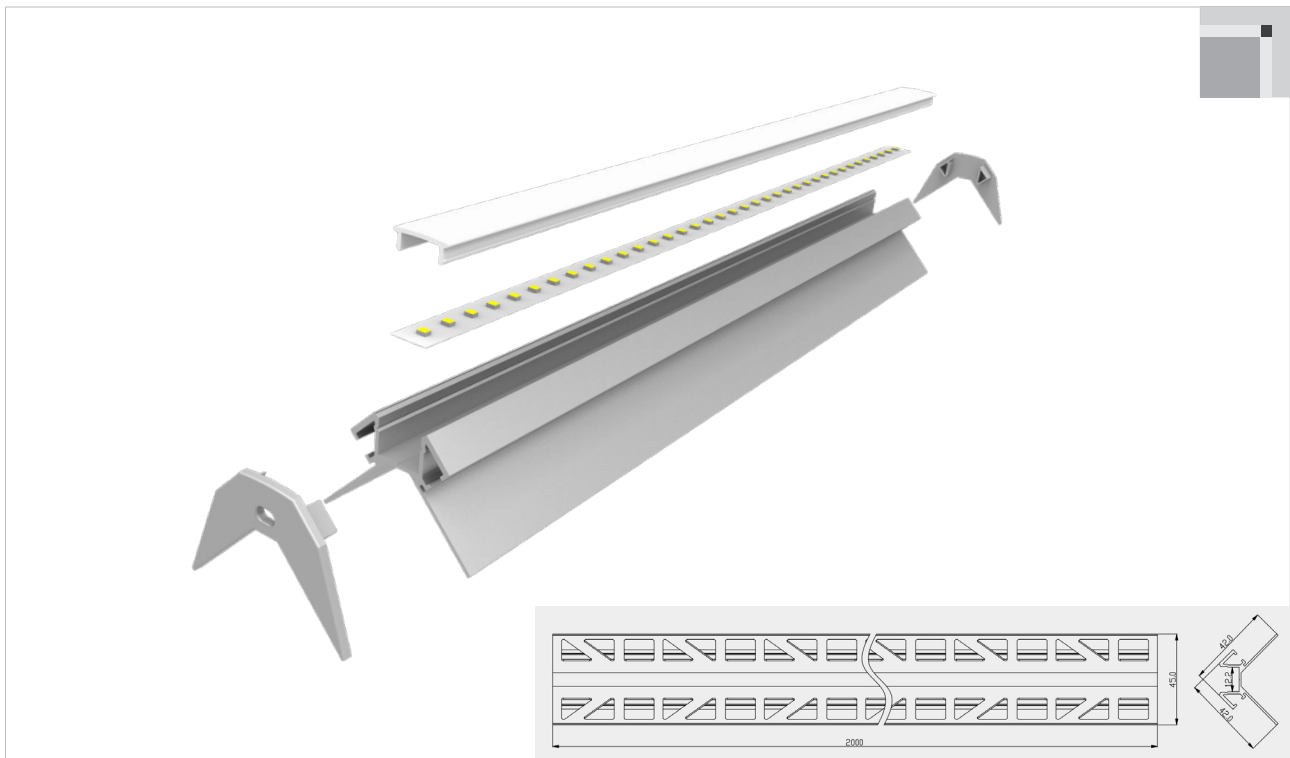

LD4343/LD4343B



Material:	AL6063-T5
Surface:	Anodized/ Painting
PC cover:	Diffuser /Transparent /Opal
Power:	14.4W/m
Input voltage:	24VDC
Lamp beads:	120/156LEDs/m (2835)
Lighting source width:	10 mm
Available lengths:	0.5-3m
Application:	Commercial lighting / Indoor lighting Artistic design/ Creative design

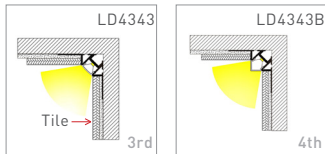
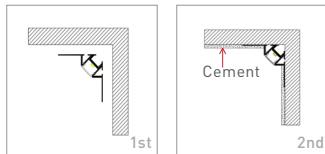
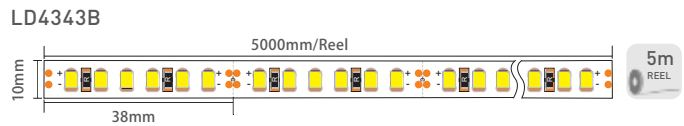
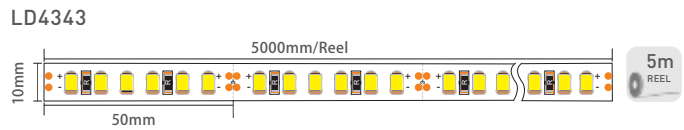
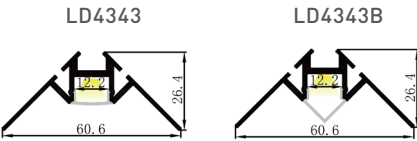
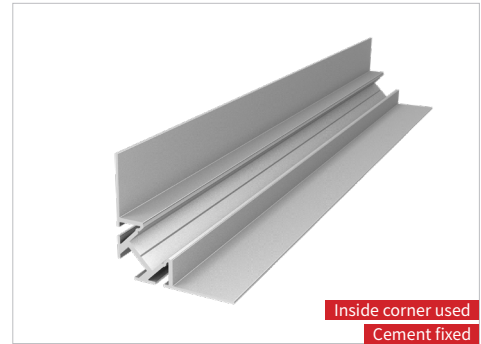

COVER

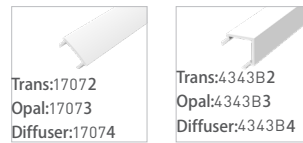

END CAP

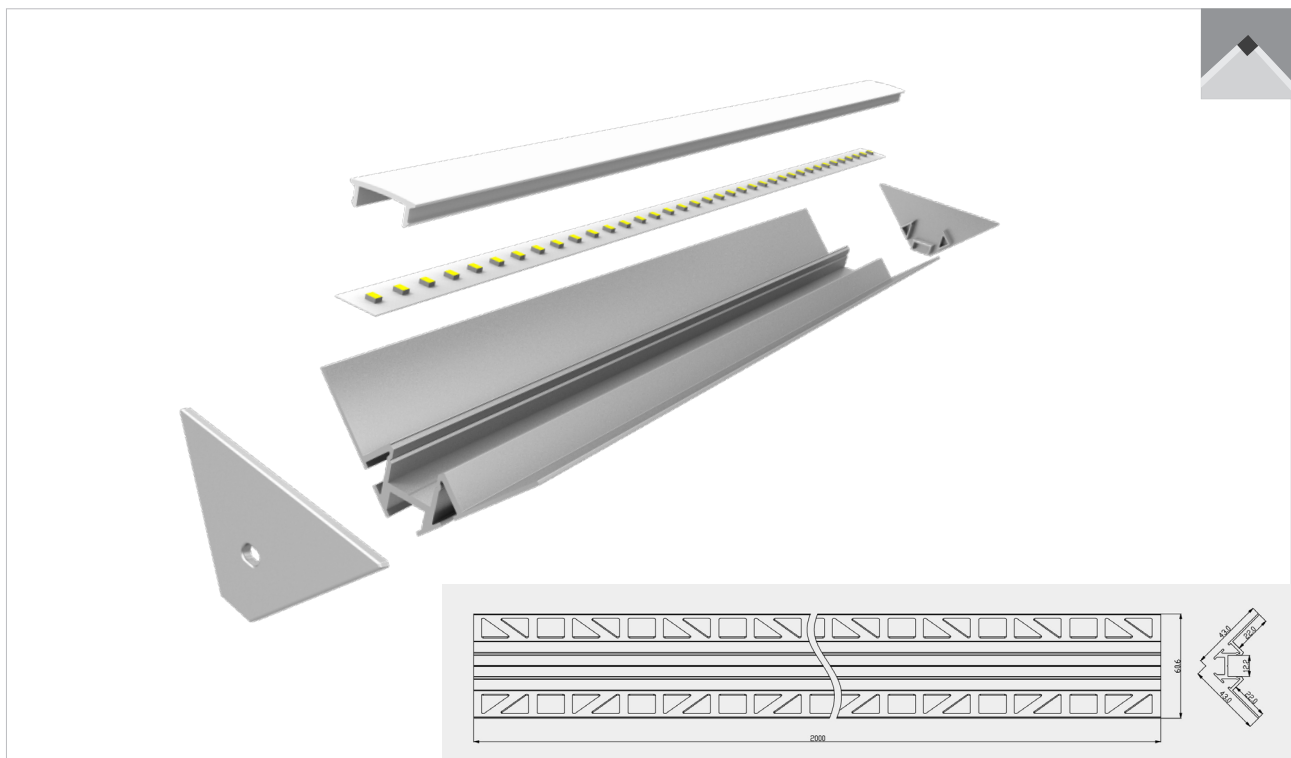
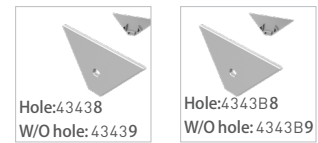

DECORATIVE PROFILE

LD4520

CE IP20

Material:	AL6063-T5
Surface:	Anodized/ Painting
PC cover:	Diffuser /Transparent /Opal
Power:	14.4W/m
Input voltage:	24VDC
Lamp beads:	120LEDs/m [2835]
Lighting source width:	10 mm
Available lengths:	0.5-3m
Application:	Commercial lighting / Indoor lighting Artistic design/ Creative design

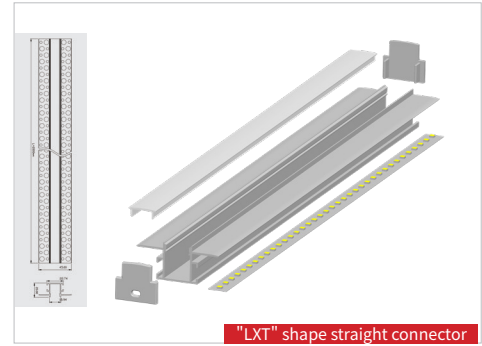

COVER

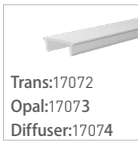

END CAP



OTHERS

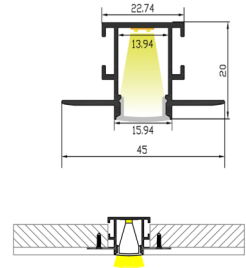
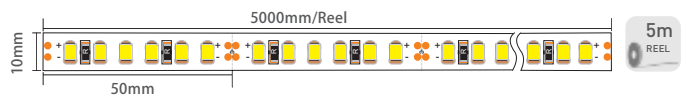

LD5815

CE IP20

Material:	AL6063-T5
Surface:	Anodized/ Painting
PC cover:	Diffuser /Transparent /Opal
Power:	14.4W/m
Input voltage:	24VDC
Lamp beads:	156LEDs/m [2835]
Lighting source width:	10mm
Available lengths:	0.5-3m
Application:	Commercial lighting / Indoor lighting Artistic design/ Creative design

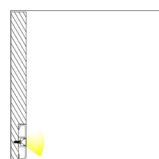

COVER

Trans:17072
Opal:17073
Diffuser:17074



END CAP

Hole:58158
W/O hole: 58159



LD6214



Material:	AL6063-T5
Surface:	Anodized/ Painting
PC cover:	Diffuser /Transparent /Opal
Power:	28.8W/m
Input voltage:	24VDC
Lamp beads:	312LEDs/m (2835)
Lighting source width:	10 mm x2pcs
Available lengths:	0.5-3m
Application:	Commercial lighting / Indoor lighting Artistic design/ Creative design

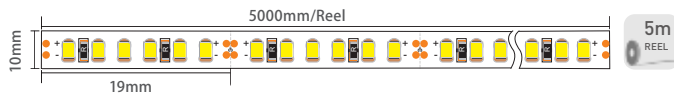
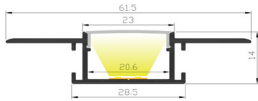
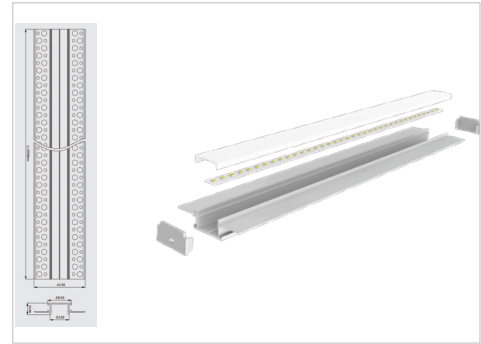

COVER



END CAP



OTHERS



LD9646



Material:	AL6063-T5
Surface:	Anodized/ Painting
PC cover:	Diffuser /Transparent /Opal
Power:	14.4W/m
Input voltage:	24VDC
Lamp beads:	120LEDs/m (2835)
Lighting source width:	10 mm
Available lengths:	0.5-3m
Application:	Commercial lighting / Indoor lighting Artistic design/ Creative design

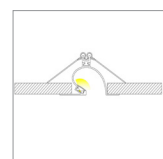
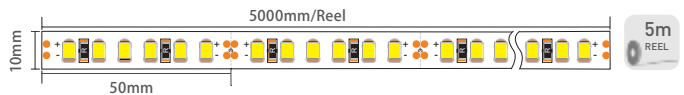
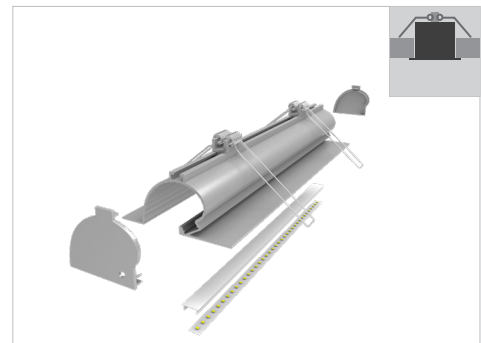

COVER



END CAP



CLIP



LD16019



Material:	AL6063-T5
Surface:	Anodized/ Painting
PC cover:	Diffuser /Transparent /Opal
Power:	14.4W/m
Input voltage:	24VDC
Lamp beads:	120LEDs/m (2835)
Lighting source width:	10 mm
Available lengths:	0.5-3m
Application:	Commercial lighting / Indoor lighting

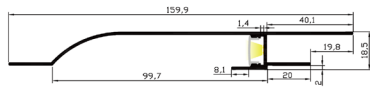
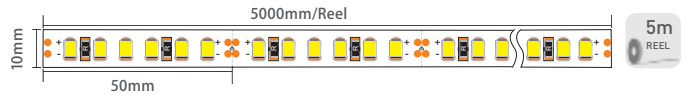
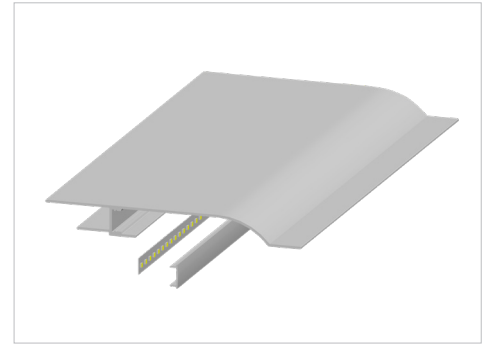

COVER

Trans:17072
Opal:17073
Diffuser:17074



DECORATIVE PROFILE

LT1046



Material:	AL6063-T5
Surface:	Anodized/ Painting
PC cover:	Transparent /Opal
Power:	28.8W /m
Input voltage:	24VDC
Lamp beads:	240LEDs/m (2835)
Lighting source width:	10 mm x2pcs
Available lengths:	0.5-3m
Application:	Commercial lighting / Indoor lighting

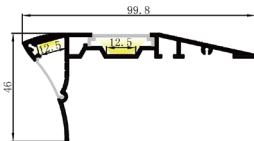

COVER

END CAP

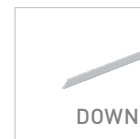

Trans :LT10462
Opal:LT10463

Trans :LT104621
Opal:LT104631

Hole:10468
W/O hole:10469

LT4322



Material:	AL6063-T5
Surface:	Anodized/ Painting
Power:	14.4W/m
Input voltage:	24VDC
Lamp beads:	120LEDs/m (3014)
Lighting source width:	4 mm
Available lengths:	0.5-3m
Application:	Stair lighting / Indoor lighting

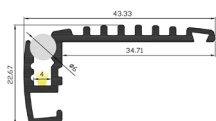
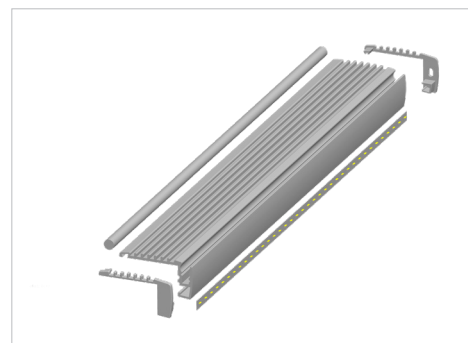

END CAP

Hole:43228
W/O hole: 43229



OTHERS

SN003



DECORATIVE PROFILE

LT5528



Material:	AL6063-T5
Surface:	Anodized/ Painting
PC cover:	Transparent /Opal
Power:	14.4W/m
Input voltage:	24VDC
Lamp beads:	120LEDs/m (2835)
Lighting source width:	10 mm
Available lengths:	0.5-3m
Application:	Commercial lighting / Indoor lighting

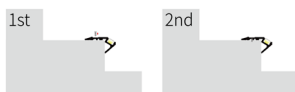
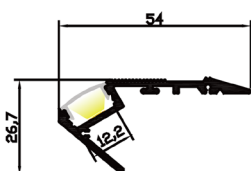

COVER

Transparent :17072
Opal: 17073



END CAP

Hole:55288
W/O hole:55289



LT5528B



Material:	AL6063-T5
Surface:	Anodized/ Painting
PC cover:	Transparent/Opal
Power:	14.4W/m
Input voltage:	24VDC
Lamp beads:	120LEDs/m [2835]
Lighting source width:	10 mm
Available lengths:	0.5-3m
Application:	Commercial lighting / Indoor lighting



DECORATIVE PROFILE

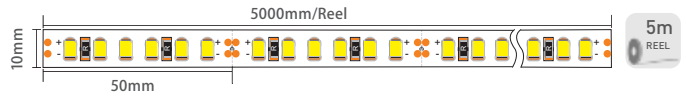
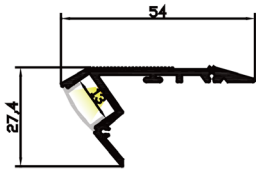

COVER
Transparent:17072
Opal: 17073



END CAP
Hole:5528B8
W/O hole:5528B9



LT6020



Material:	AL6063-T5
Surface:	Anodized/ Painting
PC cover:	Diffuser/Transparent/Opal
Power:	14.4W/m
Input voltage:	24VDC
Lamp beads:	156LEDs/m [2835]
Lighting source width:	10 mm
Available lengths:	0.5-3m
Application:	Stair lighting / Indoor lighting

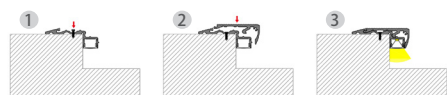
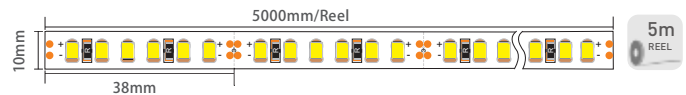
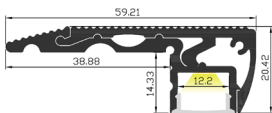
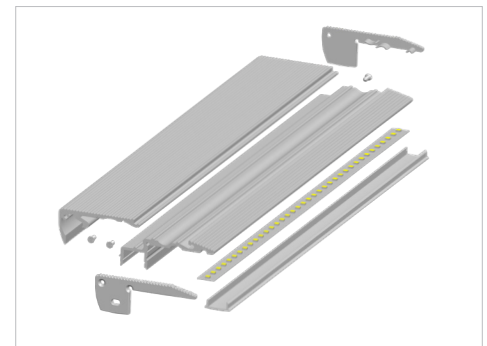

COVER
Trans:17072
Opal: 17073
Diffuser:17074



END CAP
Hole:60208
W/O hole: 60209



LT6628



Material:	AL6063-T5
Surface:	Anodized/ Painting
PC cover:	Transparent /Opal
Power:	14.4W/m
Input voltage:	24VDC
Lamp beads:	156LEDs/m (2835)
Lighting source width:	10 mm
Available lengths:	0.5-3m
Application:	Commercial lighting / Indoor lighting

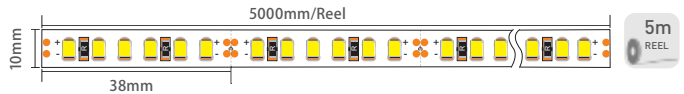
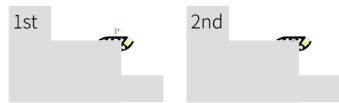
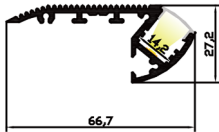

COVER Transparent :17072
Opal: 17073

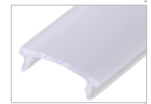

END CAP Hole:66288
W/O hole:66289



LT8050



Material:	AL6063-T5
Surface:	Anodized/ Painting
PC cover:	Diffuser/Transparent /Opal
Power:	14.4W/m
Input voltage:	24VDC
Lamp beads:	120LEDs/m (2835)
Lighting source width:	10 mm
Available lengths:	0.5-3m
Application:	Commercial lighting / Indoor lighting

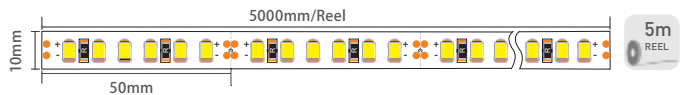
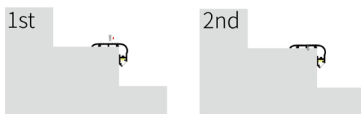
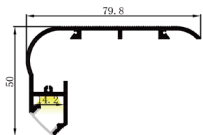

COVER Transparent :17072
Opal: 17073
Diffuser :17074



END CAP Hole:80508
W/O hole:80509

